

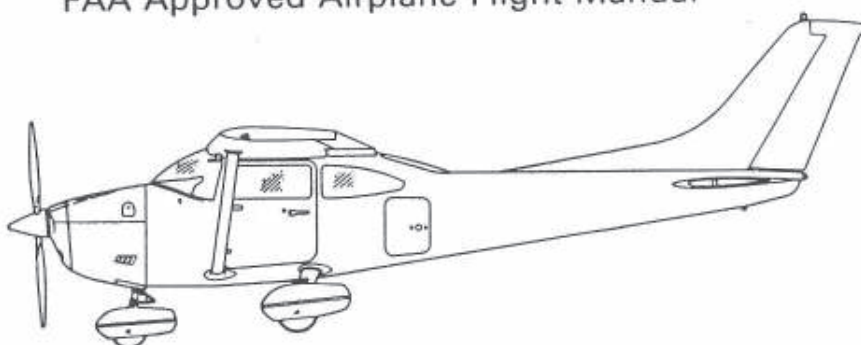

# Pilot's Operating Handbook and FAA Approved Airplane Flight Manual



Cessna Aircraft Company

1985 Model 182R

THIS DOCUMENT MUST BE  
CARRIED IN THE AIRPLANE  
AT ALL TIMES.

Serial No. 18268534

Registration No. N9460X

THIS HANDBOOK INCLUDES THE MATERIAL REQUIRED TO  
BE FURNISHED TO THE PILOT BY CAR PART 3 AND CONSTI-  
TUTES THE FAA APPROVED AIRPLANE FLIGHT MANUAL.

COPYRIGHT © 1984

Cessna Aircraft Company  
Wichita, Kansas USA

 Member of GAMA

Original Issue - 20 August 1984

PERFORMANCE-  
SPECIFICATIONS

CESSNA  
MODEL 182R

## PERFORMANCE - SPECIFICATIONS

<b>*SPEED:</b>		
Maximum at Sea Level . . . . .		148 KNOTS
Cruise, 75% Power at 8000 Ft . . . . .		142 KNOTS
<b>CRUISE: Recommended lean mixture with fuel allowance for engine start, taxi, takeoff, climb and 45 minutes reserve.</b>		
75% Power at 8000 Ft . . . . .	Range	820 NM
88 Gallons Usable Fuel . . . . .	Time	5.9 HRS
Maximum Range at 10,000 Ft . . . . .	Range	1025 NM
88 Gallons Usable Fuel . . . . .	Time	9.6 HRS
<b>RATE OF CLIMB AT SEA LEVEL . . . . .</b>		<b>865 FPM</b>
<b>SERVICE CEILING . . . . .</b>		<b>14,900 FT</b>
<b>TAKEOFF PERFORMANCE:</b>		
Ground Roll . . . . .		605 FT
Total Distance Over 50-Ft Obstacle . . . . .		1515 FT
<b>LANDING PERFORMANCE:</b>		
Ground Roll . . . . .		590 FT
Total Distance Over 50-Ft Obstacle . . . . .		1350 FT
<b>STALL SPEED (KCAS):</b>		
Flaps Up, Power Off . . . . .		54 KNOTS
Flaps Down, Power Off . . . . .		49 KNOTS
<b>MAXIMUM WEIGHT:</b>		
Ramp . . . . .		3110 LBS
Takeoff . . . . .		3100 LBS
Landing . . . . .		2950 LBS
<b>STANDARD EMPTY WEIGHT . . . . .</b>		
<b>MAXIMUM USEFUL LOAD . . . . .</b>		
<b>BAGGAGE ALLOWANCE . . . . .</b>		
<b>WING LOADING: Pounds/Sq Ft . . . . .</b>		
<b>POWER LOADING: Pounds/HP . . . . .</b>		
<b>FUEL CAPACITY: Total . . . . .</b>		
<b>OIL CAPACITY . . . . .</b>		
<b>ENGINE: Teledyne Continental . . . . .</b>		
230 BHP at 2400 RPM		
<b>PROPELLER: Constant Speed, Diameter . . . . .</b>		
82 IN.		

\*Speed performance is shown for an airplane equipped with optional speed fairings which increase the speeds by approximately 3 knots. There is a corresponding difference in range, while all other performance figures are unchanged when speed fairings are installed.

The above performance figures are based on the indicated weights, standard atmospheric conditions, level hard-surface dry runways and no wind. They are calculated values derived from flight tests conducted by the Cessna Aircraft Company under carefully documented conditions and will vary with individual airplanes and numerous factors affecting flight performance.

## COVERAGE

The Pilot's Operating Handbook in the airplane at the time of delivery from Cessna Aircraft Company contains information applicable to the 1985 Model 182R airplane designated by the serial number and registration number shown on the Title Page of this handbook. This information is based on data available at the time of publication.

## REVISIONS

Changes and/or additions to this handbook will be covered by revisions published by Cessna Aircraft Company. These revisions are distributed to owners of U.S. Registered aircraft according to FAA records at the time of revision issuance, and to Internationally Registered aircraft according to Cessna Owner Advisory records at the time of issuance.

Revisions should be examined immediately upon receipt and incorporated in this handbook.

### NOTE

**It is the responsibility of the owner to maintain this handbook in a current status when it is being used for operational purposes.**

Owners should contact their Cessna Dealer whenever the revision status of their handbook is in question.

A revision bar will extend the full length of new or revised text and/or illustrations added on new or presently existing pages. This bar will be located adjacent to the applicable revised area on the outer margin of the page.

All revised pages will carry the revision number and date on the applicable page.

The following Log of Effective Pages provides the dates of issue for original and revised pages, and a listing of all pages in the handbook. Pages affected by the current revision are indicated by an asterisk (\*) preceding the pages listed.

## LOG OF EFFECTIVE PAGES

Dates of issue for original and revised pages are:			
Original .....	20 August 1984		
Revision 1 .....	1 March 1985		
Page	Date	Page	Date
Title .....	20 August 1984	4-1 thru 4-11 .....	20 August 1984
Assignment Record .....	20 August 1984	4-12 Blank .....	20 August 1984
i thru ii .....	20 August 1984	4-13 thru 4-25 .....	20 August 1984
*iii thru iv .....	1 March 1985	4-26 Blank .....	20 August 1984
v .....	20 August 1984	5-1 .....	20 August 1984
vi Blank .....	20 August 1984	5-2 Blank .....	20 August 1984
1-1 thru 1-8 .....	20 August 1984	5-3 thru 5-7 .....	20 August 1984
2-1 .....	20 August 1984	5-8 Blank .....	20 August 1984
2-2 Blank .....	20 August 1984	5-9 thru 5-30 .....	20 August 1984
2-3 thru 2-11 .....	20 August 1984	6-1 .....	20 August 1984
2-12 Blank .....	20 August 1984	6-2 Blank .....	20 August 1984
3-1 thru 3-9 .....	20 August 1984	6-3 thru 6-30 .....	20 August 1984
3-10 Blank .....	20 August 1984	7-1 thru 7-4C .....	20 August 1984
3-11 thru 3-18 .....	20 August 1984	8-1 .....	20 August 1984

Original Issue - 20 August 1984  
Revision 1 - 1 March 1985 /D1275-1-13PH

LOG OF EFFECTIVE PAGES

CESSNA  
MODEL 182R

LOG OF EFFECTIVE PAGES (Continued)

Page	Date	Page	Date
8-2 Blank .....	20 August 1984		
8-3 thru 8-19 .....	20 August 1984		
8-20 Blank .....	20 August 1984		
*9-1 thru 9-2 .....	1 March 1985		
9-3 .....	20 August 1984		
9-4 Blank .....	20 August 1984		

NOTE

Refer to Section 9 Table of Contents for supplements applicable to optional systems.

CESSNA  
MODEL 182R

TABLE OF CONTENTS

# TABLE OF CONTENTS

	SECTION
GENERAL.....	1
LIMITATIONS.....	2
EMERGENCY PROCEDURES.....	3
NORMAL PROCEDURES.....	4
PERFORMANCE.....	5
WEIGHT & BALANCE/ EQUIPMENT LIST .....	6
AIRPLANE & SYSTEMS DESCRIPTIONS .....	7
AIRPLANE HANDLING, SERVICE & MAINTENANCE .....	8
SUPPLEMENTS (Optional Systems Description & Operating Procedures) .....	9

Original Issue

v/(vi blank)

# SECTION 1 GENERAL

## TABLE OF CONTENTS

	Page
Three View . . . . .	1-2
Introduction . . . . .	1-3
Descriptive Data . . . . .	1-3
Engine . . . . .	1-3
Propeller . . . . .	1-3
Fuel . . . . .	1-3
Oil . . . . .	1-4
Maximum Certificated Weights . . . . .	1-4
Standard Airplane Weights . . . . .	1-5
Cabin And Entry Dimensions . . . . .	1-5
Baggage Space and Entry Dimensions . . . . .	1-5
Specific Loadings . . . . .	1-5
Symbols, Abbreviations And Terminology . . . . .	1-5
General Airspeed Terminology And Symbols . . . . .	1-5
Meteorological Terminology . . . . .	1-6
Engine Power Terminology . . . . .	1-7
Airplane Performance And Flight Planning Terminology . . . . .	1-7
Weight And Balance Terminology . . . . .	1-7

SECTION 1  
GENERAL

CESSNA  
MODEL 182R

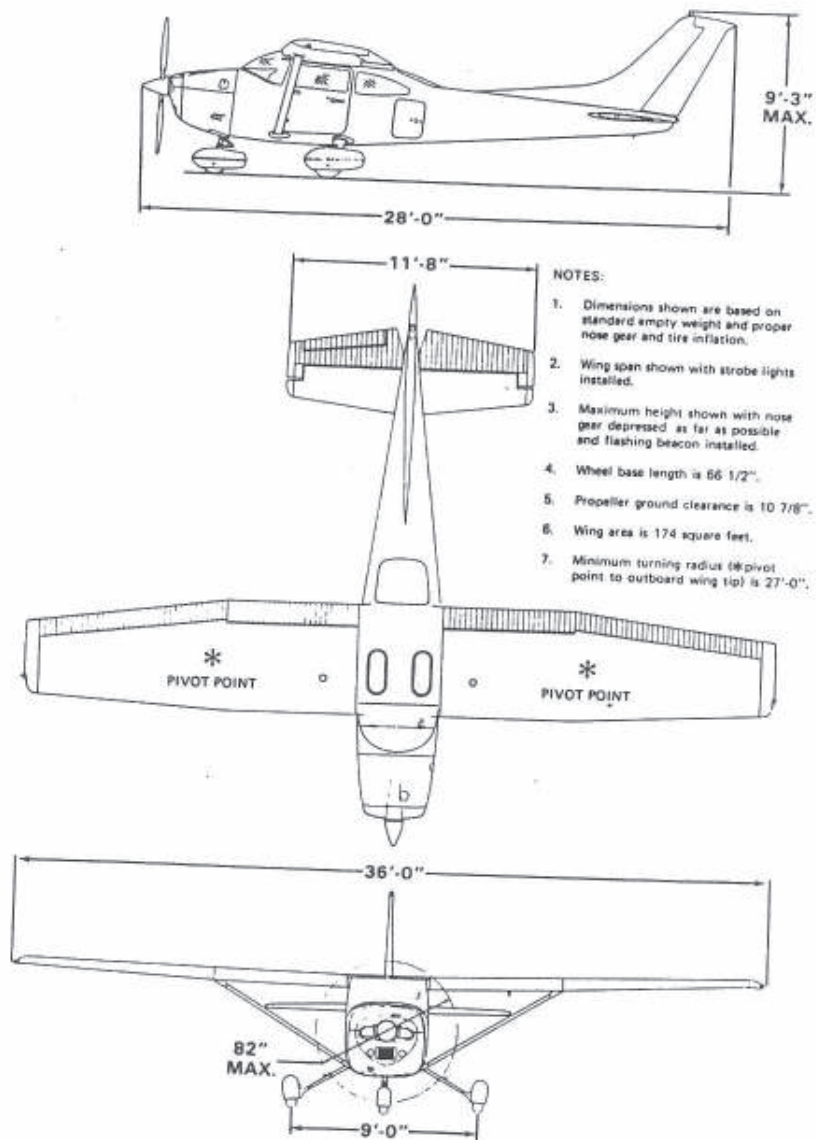

Figure 1-1. Three View

CESSNA  
MODEL 182R

SECTION 1  
GENERAL

## INTRODUCTION

This handbook contains 9 sections, and includes the material required to be furnished to the pilot by CAR Part 3. It also contains supplemental data supplied by Cessna Aircraft Company.

Section 1 provides basic data and information of general interest. It also contains definitions or explanations of symbols, abbreviations, and terminology commonly used.

## DESCRIPTIVE DATA

### ENGINE

Number of Engines: 1.  
Engine Manufacturer: Teledyne Continental.  
Engine Model Number: O-470-U.  
Engine Type: Normally-aspirated, direct-drive, air-cooled, horizontally-opposed, carburetor-equipped, six-cylinder engine with 470 cu. in. displacement.  
Horsepower Rating and Engine Speed: 230 rated BHP at 2400 RPM.

### PROPELLER

Propeller Manufacturer: McCauley Accessory Division.  
Propeller Model Number: C2A34C204/90DCB-8.  
Number of Blades: 2.  
Propeller Diameter, Maximum: 82 inches.  
Minimum: 80.5 inches.  
Propeller Type: Constant speed and hydraulically actuated, with a low pitch setting of 15.0° and a high pitch setting of 29.4° (30 inch station).

### FUEL

Approved Fuel Grades (and Colors):  
100LL Grade Aviation Fuel (Blue).  
100 (Formerly 100/130) Grade Aviation Fuel (Green).

#### NOTE

Isopropyl alcohol or ethylene glycol monomethyl ether may be added to the fuel supply. Additive concentrations shall not exceed 1% for isopropyl alcohol or .15% for ethylene glycol monomethyl ether. Refer to Section 8 for additional information.

Total Capacity: 92 gallons.  
Total Capacity Each Tank: 46 gallons.

Original Issue



SECTION 1  
GENERAL

CESSNA  
MODEL 182R

Total Usable: 88 gallons.

**NOTE**

To ensure maximum fuel capacity when refueling and minimize cross-feeding when parked on a sloping surface, place the fuel selector valve in either LEFT or RIGHT position to minimize cross-feeding.

**OIL**

**Oil Specification:**

The airplane was delivered from the factory with a corrosion-preventive aircraft engine oil. This oil should be drained after the first 25 hours of operation.

MIL-L-6082 Aviation Grade Straight Mineral Oil: Use to replenish supply during the first 25 hours.

Continental Motors Specification MHS-24 Aviation Grade Ashless Dispersant Oil: Oil conforming to Continental Motors Specification MHS-24, and all revisions or supplements thereto, must be used after first 25 hours. Refer to Continental Aircraft Engine Service Bulletin M82-8, and any superseding bulletins, revisions, or supplements thereto, for further recommendations.

**Recommended Viscosity for Temperature Range:**

All temperatures, use multi-viscosity oil or  
Above 4°C (40°F), use SAE 50  
Below 4°C (40°F), use SAE 30

**NOTE**

When operating temperatures overlap, use the lighter grade of oil. Multi-viscosity oil is recommended for improved starting in cold weather.

**Oil Capacity:**

Sump: 12 Quarts.  
Total: 13 Quarts.

**MAXIMUM CERTIFICATED WEIGHTS**

Ramp: 3110 lbs.  
Takeoff: 3100 lbs.  
Landing: 2950 lbs.

**Weight in Baggage Compartment:**

Baggage Area "A" (or passenger on child's seat) - Station 82 to 109:  
120 lbs. See note below.

Baggage Area "B" and - Station 109 to 124: 80 lbs. See note below.

Baggage Area "C" - Station 124 to 134: 80 lbs. See note below.

**NOTE**

The maximum allowable combined weight capacity for baggage in areas A, B and C is 200 pounds. The maximum allowable weight capacity for baggage in areas B and C is 80 pounds.

**STANDARD AIRPLANE WEIGHTS**

Standard Empty Weight: 1733 lbs.

Maximum Useful Load: 1377 lbs.

**CABIN AND ENTRY DIMENSIONS**

Detailed dimensions of the cabin interior and entry door openings are illustrated in Section 6.

**BAGGAGE SPACE AND ENTRY DIMENSIONS**

Dimensions of the baggage area and baggage door opening are illustrated in detail in Section 6.

**SPECIFIC LOADINGS**

Wing Loading: 17.8 lbs./sq. ft.

Power Loading: 13.5 lbs./hp.

**SYMBOLS, ABBREVIATIONS AND TERMINOLOGY**

**GENERAL AIRSPEED TERMINOLOGY AND SYMBOLS**

**KCAS**      **Knots Calibrated Airspeed** is indicated airspeed corrected for position and instrument error and expressed in knots. Knots calibrated airspeed is equal to KTAS in standard atmosphere at sea level.

**KIAS**      **Knots Indicated Airspeed** is the speed shown on the airspeed indicator and expressed in knots.

SECTION 1  
GENERAL

CESSNA  
MODEL 182R

KTAS	<b>Knots True Airspeed</b> is the airspeed expressed in knots relative to undisturbed air which is KCAS corrected for altitude and temperature.
$V_A$	<b>Maneuvering Speed</b> is the maximum speed at which full or abrupt control movements may be used.
$V_{FE}$	<b>Maximum Flap Extended Speed</b> is the highest speed permissible with wing flaps in a prescribed extended position.
$V_{NO}$	<b>Maximum Structural Cruising Speed</b> is the speed that should not be exceeded except in smooth air, then only with caution.
$V_{NE}$	<b>Never Exceed Speed</b> is the speed limit that may not be exceeded at any time.
$V_S$	<b>Stalling Speed</b> or the minimum steady flight speed at which the airplane is controllable.
$V_{S_0}$	<b>Stalling Speed</b> or the minimum steady flight speed at which the airplane is controllable in the landing configuration at the most forward center of gravity.
$V_X$	<b>Best Angle-of-Climb Speed</b> is the speed which results in the greatest gain of altitude in a given horizontal distance.
$V_Y$	<b>Best Rate-of-Climb Speed</b> is the speed which results in the greatest gain in altitude in a given time.

**METEOROLOGICAL TERMINOLOGY**

OAT	<b>Outside Air Temperature</b> is the free air static temperature. It is expressed in either degrees Celsius or degrees Fahrenheit.
Standard Temperature	<b>Standard Temperature</b> is 15°C at sea level pressure altitude and decreases by 2°C for each 1000 feet of altitude.
Pressure Altitude	<b>Pressure Altitude</b> is the altitude read from an altimeter when the altimeter's barometric scale has been set to 29.92 inches of mercury (1013 mb).

### ENGINE POWER TERMINOLOGY

BHP	<b>Brake Horsepower</b> is the power developed by the engine.
RPM	<b>Revolutions Per Minute</b> is engine speed.
MP	<b>Manifold Pressure</b> is a pressure measured in the engine's induction system and is expressed in inches of mercury (Hg).

### AIRPLANE PERFORMANCE AND FLIGHT PLANNING TERMINOLOGY

Demonstrated Crosswind Velocity	<b>Demonstrated Crosswind Velocity</b> is the velocity of the crosswind component for which adequate control of the airplane during takeoff and landing was actually demonstrated during certification tests. The value shown is not considered to be limiting.
Usable Fuel	<b>Usable Fuel</b> is the fuel available for flight planning.
Unusable Fuel	<b>Unusable Fuel</b> is the quantity of fuel that can not be safely used in flight.
GPH	<b>Gallons Per Hour</b> is the amount of fuel consumed per hour.
NMPG	<b>Nautical Miles Per Gallon</b> is the distance which can be expected per gallon of fuel consumed at a specific engine power setting and/or flight configuration.
g	<b>g</b> is acceleration due to gravity.

### WEIGHT AND BALANCE TERMINOLOGY

Reference Datum	<b>Reference Datum</b> is an imaginary vertical plane from which all horizontal distances are measured for balance purposes.
Station	<b>Station</b> is a location along the airplane fuselage given in terms of the distance from the reference datum.
Arm	<b>Arm</b> is the horizontal distance from the reference datum to the center of gravity (C.G.) of an item.
Moment	<b>Moment</b> is the product of the weight of an item multiplied
Original Issue	1-7

SECTION 1  
GENERAL

CESSNA  
MODEL 182R

by its arm. (Moment divided by the constant 1000 is used in this handbook to simplify balance calculations by reducing the number of digits.)

Center of Gravity (C.G.)	<b>Center of Gravity</b> is the point at which an airplane, or equipment, would balance if suspended. Its distance from the reference datum is found by dividing the total moment by the total weight of the airplane.
C.G. Arm	<b>Center of Gravity Arm</b> is the arm obtained by adding the airplane's individual moments and dividing the sum by the total weight.
C.G. Limits	<b>Center of Gravity Limits</b> are the extreme center of gravity locations within which the airplane must be operated at a given weight.
Standard Empty Weight	<b>Standard Empty Weight</b> is the weight of a standard airplane, including unusable fuel, full operating fluids and full engine oil.
Basic Empty Weight	<b>Basic Empty Weight</b> is the standard empty weight plus the weight of optional equipment.
Useful Load	<b>Useful Load</b> is the difference between ramp weight and the basic empty weight.
Maximum Ramp Weight	<b>Maximum Ramp Weight</b> is the maximum weight approved for ground maneuver. (It includes the weight of start, taxi and runup fuel.)
Maximum Takeoff Weight	<b>Maximum Takeoff Weight</b> is the maximum weight approved for the start of the takeoff roll.
Maximum Landing Weight	<b>Maximum Landing Weight</b> is the maximum weight approved for the landing touchdown.
Tare	<b>Tare</b> is the weight of chocks, blocks, stands, etc. used when weighing an airplane, and is included in the scale readings. Tare is deducted from the scale reading to obtain the actual (net) airplane weight.

# SECTION 2 LIMITATIONS

## TABLE OF CONTENTS

	Page
Introduction . . . . .	2-3
Airspeed Limitations . . . . .	2-4
Airspeed Indicator Markings . . . . .	2-4
Power Plant Limitations . . . . .	2-5
Power Plant Instrument Markings . . . . .	2-6
Weight Limits . . . . .	2-6
Center Of Gravity Limits . . . . .	2-7
Maneuver Limits . . . . .	2-7
Flight Load Factor Limits . . . . .	2-7
Kinds Of Operation Limits . . . . .	2-7
Fuel Limitations . . . . .	2-8
Other Limitations . . . . .	2-8
Flap Limitations . . . . .	2-8
Placards . . . . .	2-9

## INTRODUCTION

Section 2 includes operating limitations, instrument markings, and basic placards necessary for the safe operation of the airplane, its engine, standard systems and standard equipment. The limitations included in this section and in Section 9 have been approved by the Federal Aviation Administration. Observance of these operating limitations is required by Federal Aviation Regulations.

### NOTE

Refer to Section 9 of this Pilot's Operating Handbook for amended operating limitations, operating procedures, performance data and other necessary information for airplanes equipped with specific options.

### NOTE

The airspeeds listed in the Airspeed Limitations chart (figure 2-1) and the Airspeed Indicator Markings chart (figure 2-2) are based on Airspeed Calibration data shown in Section 5 with the normal static source. If the alternate static source is being used, ample margins should be observed to allow for the airspeed calibration variations between the normal and alternate static sources as shown in Section 5.

Your Cessna is certificated under FAA Type Certificate No. 3A13 as Cessna Model No. 182R.

### AIRSPEED LIMITATIONS

Airspeed limitations and their operational significance are shown in figure 2-1.

	SPEED	KCAS	KIAS	REMARKS
V <sub>NE</sub>	Never Exceed Speed	175	179	Do not exceed this speed in any operation.
V <sub>NO</sub>	Maximum Structural Cruising Speed	140	143	Do not exceed this speed except in smooth air, and then only with caution.
V <sub>A</sub>	Maneuvering Speed: 3100 Pounds 2600 Pounds 2000 Pounds	110 101 88	111 102 88	Do not make full or abrupt control movements above this speed.
V <sub>FE</sub>	Maximum Flap Extended Speed: 0° - 10° Flaps 10° - 20° Flaps 20° - FULL Flaps	137 120 95	140 120 95	Do not exceed these speeds with the given flap settings.
	Maximum Window Open Speed	175	179	Do not exceed this speed with windows open.

Figure 2-1. Airspeed Limitations

### AIRSPEED INDICATOR MARKINGS

Airspeed indicator markings and their color code significance are shown in figure 2-2.



MARKING	KIAS VALUE OR RANGE	SIGNIFICANCE
White Arc	40 - 95	Full Flap Operating Range. Lower limit is maximum weight $V_{SO}$ in landing configuration. Upper limit is maximum speed permissible with flaps extended.
Green Arc	50 - 143	Normal Operating Range. Lower limit is maximum weight $V_S$ at most forward C.G. with flaps retracted. Upper limit is maximum structural cruising speed.
Yellow Arc	143 - 179	Operations must be conducted with caution and only in smooth air.
Red Line	179	Maximum speed for all operations.

Figure 2-2. Airspeed Indicator Markings

## POWER PLANT LIMITATIONS

Engine Manufacturer: Teledyne Continental.

Engine Model Number: O-470-U.

Maximum Power: 230 BHP rating.

Engine Operating Limits for Takeoff and Continuous Operations:

Maximum Engine Speed: 2400 RPM.

Maximum Cylinder Head Temperature: 460°F (238°C).

Maximum Oil Temperature: 240°F (116°C).

Oil Pressure, Minimum: 10 psi.

Maximum: 100 psi.

Fuel Grade: See Fuel Limitations.

Oil Grade (Specification)

MIL-L-6082 Aviation Grade Straight Mineral Oil  
or Ashless Dispersant Oil conforming to Continental  
Motors Specification MHS-24 and all revisions thereto.

Propeller Manufacturer: McCauley Accessory Division.

Propeller Model Number: C2A34C204/90DCB-8

Propeller Diameter, Maximum: 82 inches.

Minimum: 80.5 inches.

Propeller Blade Angle at 30 Inch Station, Low: 15.0°.

High: 29.4°.

### POWER PLANT INSTRUMENT MARKINGS

Power plant instrument markings and their color code significance are shown in figure 2-3.

INSTRUMENT	RED LINE	GREEN ARC	RED LINE
	MINIMUM LIMIT	NORMAL OPERATING	MAXIMUM LIMIT
Tachometer	---	2100 - 2400 RPM	2400 RPM
Manifold Pressure	---	15-23 in. Hg	---
Oil Temperature	---	100° - 240°F	240°F
Cylinder Head Temperature	---	200° - 460°F	460°F
Oil Pressure	10 psi	30-60 psi	100 psi
Suction	---	4.5-5.4 in. Hg	---
Fuel Quantity	E (2.0 Gal. Unusable Each Tank)	---	---

Figure 2-3. Power Plant Instrument Markings

### WEIGHT LIMITS

- Maximum Ramp Weight: 3110 lbs.
- Maximum Takeoff Weight: 3100 lbs.
- Maximum Landing Weight: 2950 lbs.
- Maximum Weight in Baggage Compartment:
  - Baggage Area "A" (or passenger on child's seat) - Station 82 to 109: 120 lbs. See note below.
  - Baggage Area "B" - Station 109 to 124: 80 lbs. See note below.
  - Baggage Area "C" - Station 124 to 134: 80 lbs. See note below.

#### NOTE

The maximum allowable combined weight capacity for baggage in areas A, B and C is 200 pounds. The maximum allowable weight capacity for baggage in areas B and C is 80 pounds.

### CENTER OF GRAVITY LIMITS

#### Center of Gravity Range:

Forward: 33.0 inches aft of datum at 2250 lbs. or less, with straight line variation to 40.9 inches aft of datum at 3100 lbs.

Aft: 46.0 inches aft of datum at all weights.

Reference Datum: Front face of firewall.

### MANEUVER LIMITS

This airplane is certificated in the normal category. The normal category is applicable to aircraft intended for non-aerobatic operations. These include any maneuvers incidental to normal flying, stalls (except whip stalls), lazy eights, chandelles, and steep turns in which the angle of bank is not more than 60°.

Aerobatic maneuvers, including spins, are not approved.

### FLIGHT LOAD FACTOR LIMITS

#### Flight Load Factors:

\*Flaps Up: +3.8g, -1.52g

\*Flaps Down: +2.0g

\*The design load factors are 150% of the above, and in all cases, the structure meets or exceeds design loads.

### KINDS OF OPERATION LIMITS

The airplane is equipped for day VFR and may be equipped for night VFR and/or IFR operations. FAR Part 91 establishes the minimum required instrumentation and equipment for these operations. The reference to types of flight operations on the operating limitations placard reflects equipment installed at the time of Airworthiness Certificate issuance.

Flight into known icing conditions is prohibited.

## FUEL LIMITATIONS

- 2 Standard Tanks: 46 U.S. gallons each.
- Total Fuel: 92 U.S. gallons.
- Usable Fuel (all flight conditions): 88 U.S. gallons.
- Unusable Fuel: 4 U.S. gallons.

### NOTE

To ensure maximum fuel capacity when refueling and minimize cross-feeding when parked on a sloping surface, place the fuel selector valve in either LEFT or RIGHT position.

Take off and land with the fuel selector valve handle in the BOTH position.

Operation on either left or right tank limited to level flight only.

With 1/4 tank or less, prolonged uncoordinated flight is prohibited when operating on either left or right tank.

Approved Fuel Grades (and Colors):  
100LL Grade Aviation Fuel (Blue).  
100 (Formerly 100/130) Grade Aviation Fuel (Green).

## OTHER LIMITATIONS

### FLAP LIMITATIONS

Approved Takeoff Range: 0° to 20°.  
Approved Landing Range: 0° to FULL.

## PLACARDS

The following information must be displayed in the form of composite or individual placards.

1. In full view of the pilot: (The "DAY-NIGHT-VFR-IFR" entry, shown on the example below, will vary as the airplane is equipped.)

The markings and placards installed in this airplane contain operating limitations which must be complied with when operating this airplane in the Normal Category. Other operating limitations which must be complied with when operating this airplane in this category are contained in the Pilot's Operating Handbook and FAA Approved Airplane Flight Manual.

No acrobatic maneuvers, including spins, approved.

Flight into known icing conditions prohibited.

This airplane is certified for the following flight operations as of date of original airworthiness certificate:

DAY-NIGHT-VFR-IFR

2. On control lock:

CAUTION!  
CONTROL LOCK  
REMOVE BEFORE STARTING ENGINE

SECTION 2  
LIMITATIONS

CESSNA  
MODEL 182R

3. On the fuel selector valve plate:

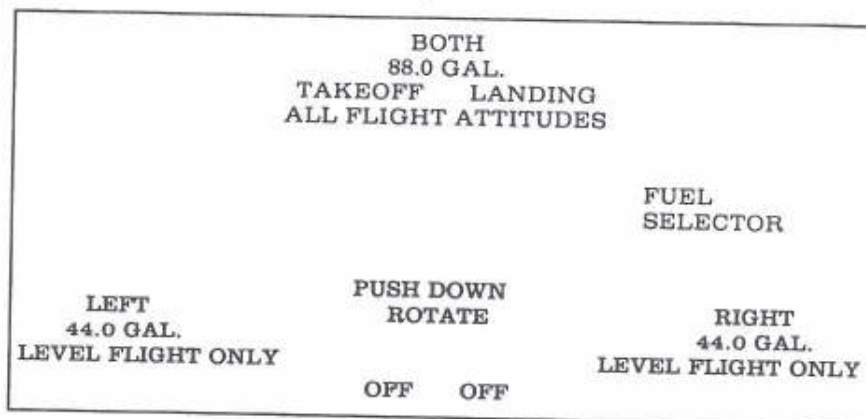

4. On the baggage door:

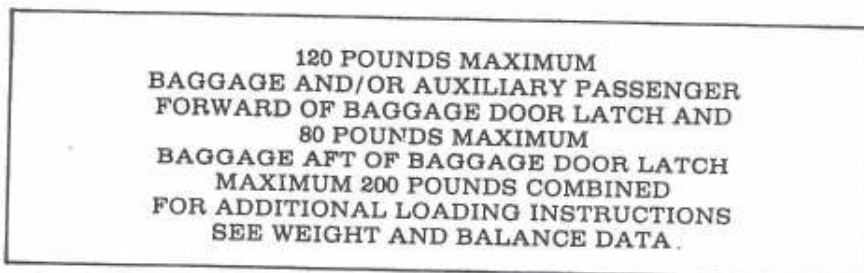

5. On flap control indicator:

0° to 10°	140 KIAS	(partial flap range with dark blue color code; also, mechanical detent at 10°.)
10° to 20°	120 KIAS	(light blue color code; also, mechanical detent at 20°.)
20° to FULL	95 KIAS	(white color code.)

6. Forward of fuel tank filler cap:

FUEL  
100LL/100 MIN. GRADE AVIATION GASOLINE  
CAP. 46.0 U.S. GAL.  
CAP. 34.5 U.S. GAL. TO BOTTOM OF FILLER NECK

7. A calibration card must be provided to indicate the accuracy of the magnetic compass in 30° increments.

8. On oil filler cap:

OIL  
12 QTS

9. Near airspeed indicator:

MANEUVER SPEED  
111 KIAS

10. On fuselage sidewall adjacent to the battery:

CAUTION            24 VOLTS D.C.  
This aircraft is equipped with alternator and a negative ground system.  
OBSERVE PROPER POLARITY  
Reverse polarity will damage electrical components.

# SECTION 3 EMERGENCY PROCEDURES

## TABLE OF CONTENTS

	Page
Introduction . . . . .	3-3
Airspeeds For Emergency Operation . . . . .	3-3
OPERATIONAL CHECKLISTS	
Engine Failures . . . . .	3-3
Engine Failure During Takeoff Roll . . . . .	3-3
Engine Failure Immediately After Takeoff . . . . .	3-4
Engine Failure During Flight (Restart Procedures) . . . . .	3-4
Forced Landings . . . . .	3-4
Emergency Landing Without Engine Power . . . . .	3-4
Precautionary Landing With Engine Power . . . . .	3-4
Ditching . . . . .	3-5
Fires . . . . .	3-5
During Start On Ground . . . . .	3-5
Engine Fire In Flight . . . . .	3-6
Electrical Fire In Flight . . . . .	3-6
Cabin Fire . . . . .	3-7
Wing Fire . . . . .	3-7
Icing . . . . .	3-7
Inadvertent Icing Encounter . . . . .	3-7
Static Source Blockage (Erroneous Instrument Reading Suspected) . . . . .	3-8
Landing With A Flat Main Tire . . . . .	3-8
Electrical Power Supply System Malfunctions . . . . .	3-9
Ammeter Shows Excessive Rate of Charge (Full Scale Deflection) . . . . .	3-9
Low-Voltage Light Illuminates During Flight (Ammeter Indicates Discharge) . . . . .	3-9
AMPLIFIED PROCEDURES	
Engine Failure . . . . .	3-11
Forced Landings . . . . .	3-12
Original Issue - 20 August 1984 . . . . .	3-1



**TABLE OF CONTENTS (Continued)**

	Page
Landing Without Elevator Control . . . . .	3-12
Fires . . . . .	3-12
Emergency Operation In Clouds (Vacuum System Failure) . . . . .	3-13
Executing A 180° Turn In Clouds . . . . .	3-13
Emergency Descent Through Clouds . . . . .	3-14
Recovery From A Spiral Dive . . . . .	3-14
Inadvertent Flight Into Icing Conditions . . . . .	3-14
Static Source Blocked . . . . .	3-15
Spins . . . . .	3-15
Rough Engine Operation Or Loss Of Power . . . . .	3-16
Carburetor Icing . . . . .	3-16
Spark Plug Fouling . . . . .	3-16
Magnetos Malfunction . . . . .	3-16
Low Oil Pressure . . . . .	3-16
Electrical Power Supply System Malfunctions . . . . .	3-17
Excessive Rate Of Charge . . . . .	3-17
Insufficient Rate Of Charge . . . . .	3-17
Other Emergencies . . . . .	3-18
Windshield Damage . . . . .	3-18

## INTRODUCTION

Section 3 provides checklist and amplified procedures for coping with emergencies that may occur. Emergencies caused by airplane or engine malfunctions are extremely rare if proper preflight inspections and maintenance are practiced. Enroute weather emergencies can be minimized or eliminated by careful flight planning and good judgment when unexpected weather is encountered. However, should an emergency arise, the basic guidelines described in this section should be considered and applied as necessary to correct the problem. Emergency procedures associated with ELT and other optional systems can be found in Section 9.

## AIRSPEEDS FOR EMERGENCY OPERATION

Engine Failure After Takeoff:	
Wing Flaps Up . . . . .	75 KIAS
Wing Flaps Down . . . . .	70 KIAS
Maneuvering Speed:	
3100 Lbs . . . . .	111 KIAS
2600 Lbs . . . . .	102 KIAS
2000 Lbs . . . . .	88 KIAS
Maximum Glide:	
3100 Lbs . . . . .	76 KIAS
2600 Lbs . . . . .	70 KIAS
2000 Lbs . . . . .	61 KIAS
Precautionary Landing With Engine Power . . . . .	70 KIAS
Landing Without Engine Power:	
Wing Flaps Up . . . . .	75 KIAS
Wing Flaps Down . . . . .	70 KIAS

## OPERATIONAL CHECKLISTS

Procedures in the Operational Checklists portion of this section shown in **bold-faced** type are immediate-action items which should be committed to memory.

## ENGINE FAILURES

### ENGINE FAILURE DURING TAKEOFF ROLL

1. **Throttle -- IDLE.**

2. Brakes -- APPLY.
3. Wing Flaps -- RETRACT.
4. Mixture -- IDLE CUT-OFF.
5. Ignition Switch -- OFF.
6. Master Switch -- OFF.

#### ENGINE FAILURE IMMEDIATELY AFTER TAKEOFF

1. Airspeed -- 75 KIAS (flaps UP).  
70 KIAS (flaps DOWN).
2. Mixture -- IDLE CUT-OFF.
3. Fuel Selector Valve -- PUSH DOWN AND ROTATE TO OFF.
4. Ignition Switch -- OFF.
5. Wing Flaps -- AS REQUIRED (FULL recommended).
6. Master Switch -- OFF.

#### ENGINE FAILURE DURING FLIGHT (RESTART PROCEDURES)

1. Airspeed -- 75 KIAS.
2. Carburetor Heat -- ON.
3. Fuel Selector Valve -- BOTH
4. Mixture -- RICH.
5. Ignition Switch -- BOTH (or START if propeller is stopped).
6. Primer -- IN and LOCKED.

### FORCED LANDINGS

#### EMERGENCY LANDING WITHOUT ENGINE POWER

1. Seats, Seat Belts, Shoulder Harnesses -- SECURE.
2. Airspeed -- 75 KIAS (flaps UP).  
70 KIAS (flaps DOWN).
3. Mixture -- IDLE CUT-OFF.
4. Fuel Selector Valve -- PUSH DOWN AND ROTATE TO OFF.
5. Ignition Switch -- OFF.
6. Wing Flaps -- AS REQUIRED (FULL recommended).
7. Master Switch -- OFF.
8. Doors -- UNLATCH PRIOR TO TOUCHDOWN.
9. Touchdown -- SLIGHTLY TAIL LOW.
10. Brakes -- APPLY HEAVILY.

#### PRECAUTIONARY LANDING WITH ENGINE POWER

1. Seats, Seat Belts, Shoulder Harnesses -- SECURE.
2. Airspeed -- 75 KIAS.
3. Wing Flaps -- 20°.
4. Selected Field -- FLY OVER, noting terrain and obstructions, then

- retract flaps upon reaching a safe altitude and airspeed.
5. Electrical Switches -- OFF.
  6. Wing Flaps -- FULL (on final approach).
  7. Airspeed -- 70 KIAS.
  8. Avionics Power and Master Switches -- OFF.
  9. Doors -- UNLATCH PRIOR TO TOUCHDOWN.
  10. Touchdown -- SLIGHTLY TAIL LOW.
  11. Ignition Switch -- OFF.
  12. Brakes -- APPLY HEAVILY.

### DITCHING

1. Radio -- TRANSMIT MAYDAY on 121.5 MHz, giving location and intentions and SQUAWK 7700 if transponder is installed.
2. Heavy Objects (in baggage area) -- SECURE OR JETTISON.
3. Seats, Seat Belts, Shoulder Harnesses -- SECURE.
4. Flaps -- 20° to FULL.
5. Power -- ESTABLISH 300 FT/MIN DESCENT at 65 KIAS.
6. Approach -- High Winds, Heavy Seas -- INTO THE WIND.  
Light Winds, Heavy Swells -- PARALLEL TO SWELLS.

### NOTE

If no power is available, approach at 70 KIAS with flaps up or at 65 KIAS with 10° flaps.

7. Cabin Doors -- UNLATCH.
8. Touchdown -- LEVEL ATTITUDE AT ESTABLISHED DESCENT.
9. Face -- CUSHION at touchdown with folded coat.
10. Airplane -- EVACUATE through cabin doors. If necessary, open windows and flood cabin to equalize pressure so doors can be opened.
11. Life Vests and Raft -- INFLATE.

### FIRES

#### DURING START ON GROUND

1. Cranking -- CONTINUE, to get a start which would suck the flames and accumulated fuel through the carburetor and into the engine.

If engine starts:

2. Power -- 1700 RPM for a few minutes.
3. Engine -- SHUTDOWN and inspect for damage.

If engine fails to start:

4. Throttle -- FULL OPEN.
5. Mixture -- IDLE CUT-OFF.
6. Cranking -- CONTINUE.
7. Fire Extinguisher -- OBTAIN (have ground attendants obtain if not installed).
8. Engine -- SECURE.
  - a. Master Switch -- OFF.
  - b. Ignition Switch -- OFF.
  - c. Fuel Selector Valve -- PUSH DOWN AND ROTATE TO OFF.
9. Fire -- EXTINGUISH using fire extinguisher, wool blanket, or dirt.
10. Fire Damage -- INSPECT, repair damage or replace damaged components or wiring before conducting another flight.

#### ENGINE FIRE IN FLIGHT

1. Mixture -- IDLE CUT-OFF.
2. Fuel Selector Valve -- PUSH DOWN AND ROTATE TO OFF.
3. Master Switch -- OFF.
4. Cabin Heat and Air -- OFF (except overhead vents).
5. Airspeed -- 100 KIAS (If fire is not extinguished, increase glide speed to find an airspeed which will provide an incombustible mixture).
6. Forced Landing -- EXECUTE (as described in Emergency Landing Without Engine Power).

#### ELECTRICAL FIRE IN FLIGHT

1. Master Switch -- OFF.
2. Vents/Cabin Air/Heat -- CLOSED.
3. Fire Extinguisher -- ACTIVATE (if available).

#### WARNING

After discharging an extinguisher within a closed cabin, ventilate the cabin.

4. Avionics Power Switch -- OFF.
5. All Other Switches (except ignition switch) -- OFF.

If fire appears out and electrical power is necessary for continuance of flight:

6. Master Switch -- ON.
7. Circuit Breakers -- CHECK for faulty circuit, do not reset.

8. Radio Switches -- OFF.
9. Avionics Power Switch -- ON.
10. Radio/Electrical Switches -- ON one at a time, with delay after each until short circuit is localized.
11. Vents/Cabin Air/Heat -- OPEN when it is ascertained that fire is completely extinguished.

#### CABIN FIRE

1. Master Switch -- OFF.
2. Vents/Cabin Air/Heat -- CLOSED (to avoid drafts).
3. Fire Extinguisher -- ACTIVATE (if available).

#### WARNING

After discharging an extinguisher within a closed cabin, ventilate the cabin.

4. Land the airplane as soon as possible to inspect for damage.

#### WING FIRE

1. Pitot Heat Switch (if installed) -- OFF.
2. Navigation Light Switch -- OFF.
3. Strobe Light Switch (if installed) -- OFF.

#### NOTE

Perform a sideslip to keep the flames away from the fuel tank and cabin, and land as soon as possible using flaps only as required for final approach and touchdown.

### ICING

#### INADVERTENT ICING ENCOUNTER

1. Turn pitot heat switch ON (if installed).
2. Turn back or change altitude to obtain an outside air temperature that is less conducive to icing.
3. Pull cabin heat control full out and rotate defroster control clockwise to obtain maximum defroster airflow.
4. Increase engine speed to minimize ice build-up on propeller blades.
5. Watch for signs of carburetor air filter ice and apply carburetor

heat as required. An unexplained loss in manifold pressure could be caused by carburetor ice or air intake filter ice. Lean the mixture if carburetor heat is used continuously.

6. Plan a landing at the nearest airport. With an extremely rapid ice build-up, select a suitable "off airport" landing site.
7. With an ice accumulation of 1/4 inch or more on the wing leading edges, be prepared for significantly higher stall speed.
8. Leave wing flaps retracted. With a severe ice build-up on the horizontal tail, the change in wing wake airflow direction caused by wing flap extension could result in a loss of elevator effectiveness.
9. Open left window and if practical scrape ice from a portion of the windshield for visibility in the landing approach.
10. Perform a landing approach using a forward slip, if necessary, for improved visibility.
11. Approach at 80 to 90 KIAS depending upon the amount of ice accumulation.
12. Perform a landing in level attitude.

#### STATIC SOURCE BLOCKAGE (Erroneous Instrument Reading Suspected)

1. Static Pressure Alternate Source Valve (if installed) -- PULL ON.

#### NOTE

In an emergency on airplanes not equipped with an alternate static source, cabin pressure can be supplied to the static pressure instruments by breaking the glass in the face of the vertical speed indicator.

2. Airspeed -- Consult appropriate table in Section 5.
3. Altitude -- Cruise 50 feet higher and approach 30 feet higher than normal.

#### LANDING WITH A FLAT MAIN TIRE

1. Approach -- NORMAL.
2. Wing Flaps -- FULL DOWN.
3. Touchdown -- GOOD TIRE FIRST, hold airplane off flat tire as long as possible with aileron control.
4. Directional Control -- MAINTAIN using brake on good wheel as required.

## ELECTRICAL POWER SUPPLY SYSTEM MALFUNCTIONS

### AMMETER SHOWS EXCESSIVE RATE OF CHARGE (Full Scale Deflection)

1. Alternator -- OFF.

#### CAUTION

With the alternator side of the master switch off, compass deviations of as much as 25° may occur.

2. Alternator Circuit Breaker -- PULL.
3. Nonessential Electrical Equipment -- OFF.
4. Flight -- TERMINATE as soon as practical.

### LOW-VOLTAGE LIGHT ILLUMINATES DURING FLIGHT (Ammeter Indicates Discharge)

#### NOTE

Illumination of the low-voltage light may occur during low RPM conditions with an electrical load on the system such as during a low RPM taxi. Under these conditions, the light will go out at higher RPM. The master switch need not be recycled since an over-voltage condition has not occurred to de-activate the alternator system.

1. Avionics Power Switch -- OFF.
2. Alternator Circuit Breaker -- CHECK IN.
3. Master Switch -- OFF (both sides).
4. Master Switch -- ON.
5. Low-Voltage Light -- CHECK OFF.
6. Avionics Power Switch -- ON.

If low-voltage light illuminates again:

7. Alternator -- OFF.

#### CAUTION

With the alternator side of the master switch off, compass deviations of as much as 25° may occur.

8. Nonessential Radio and Electrical Equipment -- OFF.
9. Flight -- TERMINATE as soon as practical.



## AMPLIFIED PROCEDURES

The following Amplified Procedures elaborate upon information contained in the Operational Checklists portion of this section. These procedures also include information not readily adaptable to a checklist format, and material to which a pilot could not be expected to refer in resolution of a specific emergency.

### ENGINE FAILURE

If an engine failure occurs during the takeoff run, the most important thing to do is stop the airplane on the remaining runway. Those extra items on the checklist will provide added safety after a failure of this type.

Prompt lowering of the nose to maintain airspeed and establish a glide attitude is the first response to an engine failure after takeoff. In most cases, the landing should be planned straight ahead with only small changes in direction to avoid obstructions. Altitude and airspeed are seldom sufficient to execute a 180° gliding turn necessary to return to the runway. The checklist procedures assume that adequate time exists to secure the fuel and ignition systems prior to touchdown.

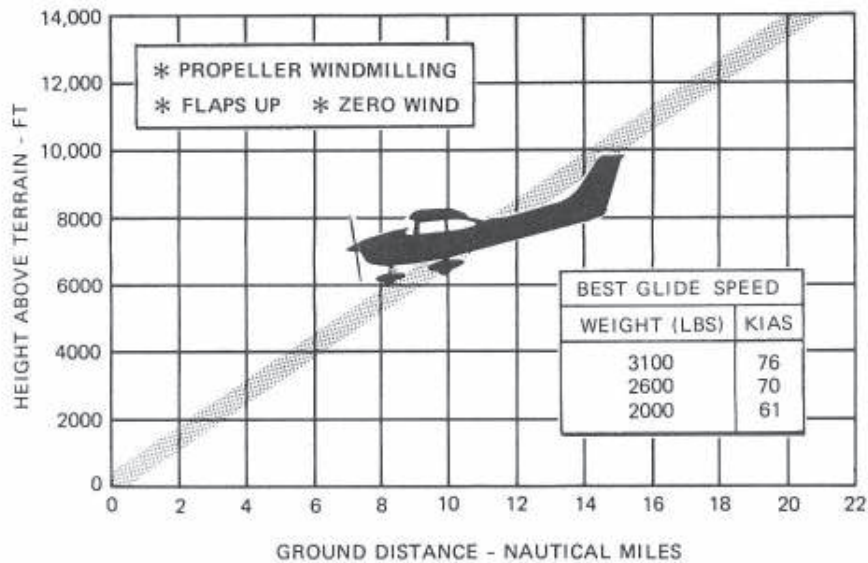

Figure 3-1. Maximum Glide

After an engine failure in flight, the best glide speed as shown in figure 3-1 should be established as quickly as possible. While gliding toward a suitable landing area, an effort should be made to identify the cause of the failure. If time permits, an engine restart should be attempted as shown in the checklist. If the engine cannot be restarted, a forced landing without power must be completed.

## FORCED LANDINGS

If all attempts to restart the engine fail and a forced landing is imminent, select a suitable field and prepare for the landing as discussed in the checklist for Emergency Landing Without Engine Power.

Before attempting an "off airport" landing with engine power available, one should fly over the landing area at a safe but low altitude to inspect the terrain for obstructions and surface conditions, proceeding as discussed under the Precautionary Landing With Engine Power checklist.

Prepare for ditching by securing or jettisoning heavy objects located in the baggage area and collect folded coats for protection of occupants' face at touchdown. Transmit Mayday message on 121.5 MHz giving location and intentions and squawk 7700 if a transponder is installed. Avoid a landing flare because of difficulty in judging height over a water surface.

In a forced landing situation, do not turn off the avionics power and master switches until a landing is assured. Premature deactivation of the switches will disable the encoding altimeter and airplane electrical systems.

## LANDING WITHOUT ELEVATOR CONTROL

Trim for horizontal flight with an airspeed of approximately 80 KIAS by using throttle and elevator trim control. Then **do not change the elevator trim control setting**; control the glide angle by adjusting power exclusively.

At flareout, the nose-down moment resulting from power reduction is an adverse factor and the airplane may hit on the nose wheel. Consequently, at flareout, the elevator trim control should be adjusted toward the full nose-up position and the power adjusted so that the airplane will rotate to the horizontal attitude for touchdown. Close the throttle at touchdown.

## FIRES

Although engine fires are extremely rare in flight, the steps of the appropriate checklist should be followed if one is encountered. After

completion of this procedure, execute a forced landing. Do not attempt to restart the engine.

The initial indication of an electrical fire is usually the odor of burning insulation. The checklist for this problem should result in elimination of the fire.

## EMERGENCY OPERATION IN CLOUDS (Vacuum System Failure)

If the optional electric standby vacuum pump is not installed and a complete vacuum system failure occurs during flight, the directional indicator and attitude indicator will be disabled, and the pilot will have to rely on the turn coordinator if he inadvertently flies into clouds. If an autopilot is installed, it too may be affected. For instance, a 200A autopilot will remain functional and can be used following a vacuum system failure. However, only the basic wings leveling mode of a 300A will function after a vacuum failure, but other modes should not be considered usable. Refer to Section 9, Supplements, for additional details concerning autopilot and/or electric standby vacuum pump operation. The following instructions assume that only the electrically-powered turn coordinator is operative, and that the pilot is not completely proficient in instrument flying.

### EXECUTING A 180° TURN IN CLOUDS

Upon inadvertently entering the clouds, an immediate plan should be made to turn back as follows:

1. Note the compass heading.
2. Note the time of the minute hand and observe the position of the sweep second hand on the clock.
3. When the sweep second hand indicates the nearest half-minute, initiate a standard rate left turn, holding the turn coordinator symbolic airplane wing opposite the lower left index mark for 60 seconds. Then roll back to level flight by leveling the miniature airplane.
4. Check accuracy of the turn by observing the compass heading which should be the reciprocal of the original heading.
5. If necessary, adjust heading primarily with skidding motions rather than rolling motions so that the compass will read more accurately.
6. Maintain altitude and airspeed by cautious application of elevator control. Avoid overcontrolling by keeping the hands off the control wheel as much as possible and steering only with rudder.

### EMERGENCY DESCENT THROUGH CLOUDS

If conditions preclude reestablishment of VFR flight by a 180° turn, a descent through a cloud deck to VFR conditions may be appropriate. If possible, obtain radio clearance for an emergency descent through clouds. To guard against a spiral dive, choose an easterly or westerly heading to minimize compass card swings due to changing bank angles. In addition, keep hands off the control wheel and steer a straight course with rudder control by monitoring the turn coordinator. Occasionally check the compass heading and make minor corrections to hold an approximate course. Before descending into the clouds, set up a stabilized let-down condition as follows:

1. Apply full rich mixture.
2. Apply full carburetor heat.
3. Reduce power to set up a 500 to 800 ft/min rate of descent.
4. Adjust the elevator and rudder trim control wheels for a stabilized descent at 80 KIAS.
5. Keep hands off control wheel.
6. Monitor turn coordinator and make corrections by rudder alone.
7. Adjust rudder trim to relieve unbalanced rudder force, if present.
8. Check trend of compass card movement and make cautious corrections with rudder to stop turn.
9. Upon breaking out of clouds, resume normal cruising flight.

### RECOVERY FROM A SPIRAL DIVE

If a spiral is encountered, proceed as follows:

1. Retard the throttle to idle position.
2. Stop the turn by using coordinated aileron and rudder control to align the symbolic airplane in the turn coordinator with the horizon reference line.
3. Cautiously apply elevator back pressure to slowly reduce the indicated airspeed to 80 KIAS.
4. Adjust the elevator trim control to maintain an 80 KIAS glide.
5. Keep hands off the control wheel, using rudder control to hold a straight heading. Use rudder trim to relieve unbalanced rudder force, if present.
6. Apply carburetor heat.
7. Clear engine occasionally, but avoid using enough power to disturb the trimmed glide.
8. Upon breaking out of clouds, resume normal cruising flight.

### INADVERTENT FLIGHT INTO ICING CONDITIONS

Flight into icing conditions is prohibited. An inadvertent encounter

with these conditions can best be handled using the checklist procedures. The best procedure, of course, is to turn back or change altitude to escape icing conditions.

### STATIC SOURCE BLOCKED

If erroneous readings of the static source instruments (airspeed, altimeter and vertical speed) are suspected due to water, ice or other foreign matter in the pressure lines going to the standard external static pressure sources, the static pressure alternate source valve should be pulled on. A chart in Section 5 provides a correction which may be applied to the indicated airspeeds listed in this handbook resulting from inaccuracies in the alternate static source pressures. To avoid the possibility of large errors, the windows should not be open when using the alternate static source.

#### NOTE

In an emergency on airplanes not equipped with an alternate static source, cabin pressure can be supplied to the static pressure instruments by breaking the glass in the face of the vertical speed indicator.

### SPINS

Intentional spins are prohibited in this airplane. Should an inadvertent spin occur, the following recovery procedure should be used:

1. RETARD THROTTLE TO IDLE POSITION.
2. PLACE AILERONS IN NEUTRAL POSITION.
3. APPLY AND **HOLD** FULL RUDDER OPPOSITE TO THE DIRECTION OF ROTATION.
4. **JUST AFTER** THE RUDDER REACHES THE STOP, MOVE THE WHEEL **BRISKLY** FORWARD FAR ENOUGH TO BREAK THE STALL.
5. **HOLD** THESE CONTROL INPUTS UNTIL ROTATION STOPS. Premature relaxation of the control inputs may extend the recovery.
6. AS ROTATION STOPS, NEUTRALIZE RUDDER, AND MAKE A SMOOTH RECOVERY FROM THE RESULTING DIVE.

#### NOTE

If disorientation precludes a visual determination of the direction of rotation, the symbolic airplane in the turn coordinator may be referred to for this information.

## **ROUGH ENGINE OPERATION OR LOSS OF POWER**

### **CARBURETOR ICING**

An unexplained drop in manifold pressure and eventual engine roughness may result from the formation of carburetor ice. To clear the ice, apply full throttle and pull the carburetor heat knob full out until the engine runs smoothly; then remove carburetor heat and readjust the throttle. If conditions require the continued use of carburetor heat in cruise flight, use the minimum amount of heat necessary to prevent ice from forming and lean the mixture for smoothest engine operation.

### **SPARK PLUG FOULING**

A slight engine roughness in flight may be caused by one or more spark plugs becoming fouled by carbon or lead deposits. This may be verified by turning the ignition switch momentarily from BOTH to either L or R position. An obvious power loss in single ignition operation is evidence of spark plug or magneto trouble. Assuming that spark plugs are the more likely cause, lean the mixture to the recommended lean setting for cruising flight. If the problem does not clear up in several minutes, determine if a richer mixture setting will produce smoother operation. If not, proceed to the nearest airport for repairs using the BOTH position of the ignition switch unless extreme roughness dictates the use of a single ignition position.

### **MAGNETO MALFUNCTION**

A sudden engine roughness or misfiring is usually evidence of magneto problems. Switching from BOTH to either L or R ignition switch position will identify which magneto is malfunctioning. Select different power settings and enrichen the mixture to determine if continued operation on BOTH magnetos is practicable. If not, switch to the good magneto and proceed to the nearest airport for repairs.

### **LOW OIL PRESSURE**

If low oil pressure is accompanied by normal oil temperature, there is a possibility the oil pressure gage or relief valve is malfunctioning. A leak in the line to the gage is not necessarily cause for an immediate precautionary landing because an orifice in this line will prevent a sudden loss of oil from the engine sump. However, a landing at the nearest airport would be advisable to inspect the source of trouble.

If a total loss of oil pressure is accompanied by a rise in oil tempera-

ture, there is good reason to suspect an engine failure is imminent. Reduce engine power immediately and select a suitable forced landing field. Use only the minimum power required to reach the desired touchdown spot.

## **ELECTRICAL POWER SUPPLY SYSTEM MALFUNCTIONS**

Malfunctions in the electrical power supply system can be detected by periodic monitoring of the ammeter and low-voltage warning light; however, the cause of these malfunctions is usually difficult to determine. A broken alternator drive belt or wiring is most likely the cause of alternator failures, although other factors could cause the problem. A defective alternator control unit can also cause malfunctions. Problems of this nature constitute an electrical emergency and should be dealt with immediately. Electrical power malfunctions usually fall into two categories: excessive rate of charge and insufficient rate of charge. The paragraphs below describe the recommended remedy for each situation.

### **EXCESSIVE RATE OF CHARGE**

After engine starting and heavy electrical usage at low engine speeds (such as extended taxiing) the battery condition will be low enough to accept above normal charging during the initial part of a flight. However, after thirty minutes of cruising flight, the ammeter should be indicating less than two needle widths of charging current. If the charging rate were to remain above this value on a long flight, the battery would overheat and evaporate the electrolyte at an excessive rate.

Electronic components in the electrical system can be adversely affected by higher than normal voltage. The alternator control unit includes an over-voltage sensor which normally will automatically shut down the alternator if the charge voltage reaches approximately 31.5 volts. If the over-voltage sensor malfunctions, as evidenced by an excessive rate of charge shown on the ammeter, the alternator should be turned off, alternator circuit breaker pulled, nonessential electrical equipment turned off and the flight terminated as soon as practical.

### **INSUFFICIENT RATE OF CHARGE**

#### **NOTE**

Illumination of the low-voltage light and ammeter discharge indications may occur during low RPM conditions with an electrical load on the system, such as during a low RPM taxi. Under these conditions, the light will go out at

higher RPM. The master switch need not be recycled since an over-voltage condition has not occurred to de-activate the alternator system.

If the over-voltage sensor should shut down the alternator or if the alternator output is low, a discharge rate will be shown on the ammeter followed by illumination of the low-voltage warning light. Since this may be a "nuisance" trip-out, an attempt should be made to reactivate the alternator system. To do this, turn the avionics power switch off, check that the alternator circuit breaker is in, then turn both sides of the master switch off and then on again. If the problem no longer exists, normal alternator charging will resume and the low-voltage light will go off. The avionics power switch may then be turned back on. If the light illuminates again, a malfunction is confirmed. In this event, the flight should be terminated and/or the current drain on the battery minimized because the battery can supply the electrical system for only a limited period of time. If the emergency occurs at night, power must be conserved for later use of the landing lights and flaps during landing.

## OTHER EMERGENCIES

### WINDSHIELD DAMAGE

If a bird strike or other incident should damage the windshield in flight to the point of creating an opening, a significant loss in performance may be expected. This loss may be minimized in some cases (depending on amount of damage, altitude, etc.) by opening the side windows while the airplane is maneuvered for a landing at the nearest airport.

If airplane performance or other adverse conditions preclude landing at an airport, prepare for an "off airport" landing in accordance with the Precautionary Landing With Engine Power or Ditching checklists.



# SECTION 4

## NORMAL PROCEDURES

### TABLE OF CONTENTS

	Page
Introduction . . . . .	4-3
Speeds For Normal Operation . . . . .	4-3
<b>CHECKLIST PROCEDURES</b>	
Preflight Inspection . . . . .	4-5
Cabin . . . . .	4-5
Empennage . . . . .	4-5
Right Wing, Trailing Edge . . . . .	4-5
Right Wing . . . . .	4-5
Nose . . . . .	4-6
Left Wing . . . . .	4-6
Left Wing, Leading Edge . . . . .	4-7
Left Wing, Trailing Edge . . . . .	4-7
Before Starting Engine . . . . .	4-7
Starting Engine . . . . .	4-7
Before Takeoff . . . . .	4-8
Takeoff . . . . .	4-9
Normal Takeoff . . . . .	4-9
Short Field Takeoff . . . . .	4-9
Enroute Climb . . . . .	4-9
Normal Climb . . . . .	4-9
Maximum Performance Climb . . . . .	4-9
Cruise . . . . .	4-10
Descent . . . . .	4-10
Before Landing . . . . .	4-10
Landing . . . . .	4-10
Normal Landing . . . . .	4-10
Short Field Landing . . . . .	4-11
Balked Landing . . . . .	4-11
After Landing . . . . .	4-11
Securing Airplane . . . . .	4-11
 Original Issue - 20 August 1984	 4-1

**TABLE OF CONTENTS (Continued)**

	Page
<b>AMPLIFIED PROCEDURES</b>	
Preflight Inspection . . . . .	4-13
Starting Engine . . . . .	4-14
Taxiing . . . . .	4-16
Before Takeoff . . . . .	4-16
Warm-Up . . . . .	4-16
Magnetos Check . . . . .	4-16
Alternator Check . . . . .	4-16
Takeoff . . . . .	4-17
Power Check . . . . .	4-17
Wing Flap Settings . . . . .	4-17
Crosswind Takeoff . . . . .	4-17
Enroute Climb . . . . .	4-18
Cruise . . . . .	4-18
Leaning With A Cessna Economy Mixture Indicator (EGT) . . . . .	4-20
Stalls . . . . .	4-20
Landing . . . . .	4-21
Normal Landing . . . . .	4-21
Short Field Landing . . . . .	4-21
Crosswind Landing . . . . .	4-21
Balked Landing . . . . .	4-21
Cold Weather Operation . . . . .	4-21
Starting . . . . .	4-22
Operation . . . . .	4-24
Hot Weather Operation . . . . .	4-25
Noise Characteristics . . . . .	4-25

## INTRODUCTION

Section 4 provides checklist and amplified procedures for the conduct of normal operation. Normal procedures associated with optional systems can be found in Section 9.

## SPEEDS FOR NORMAL OPERATION

Unless otherwise noted, the following speeds are based on a maximum takeoff weight or maximum landing weight, and may be used for any lesser weight. However, to achieve the performance specified in Section 5 for takeoff distance, the speed appropriate to the particular weight must be used.

### Takeoff:

Normal Climb Out . . . . .	70-80 KIAS
Short Field Takeoff, Flaps 20°, Speed at 50 Feet . . . . .	59 KIAS
Enroute Climb, Flaps Up:	
Normal . . . . .	85-95 KIAS
Best Rate of Climb, Sea Level . . . . .	81 KIAS
Best Rate of Climb, 10,000 Feet . . . . .	75 KIAS
Best Angle of Climb, Sea Level . . . . .	59 KIAS
Best Angle of Climb, 10,000 Feet . . . . .	66 KIAS
Landing Approach (2950 Lbs):	
Normal Approach, Flaps Up . . . . .	70-80 KIAS
Normal Approach, Flaps FULL . . . . .	60-70 KIAS
Short Field Approach, Flaps FULL . . . . .	61 KIAS
Balked Landing (2950 Lbs):	
Maximum Power, Flaps 20° . . . . .	55 KIAS
Maximum Recommended Turbulent Air Penetration Speed:	
3100 Lbs . . . . .	111 KIAS
2600 Lbs . . . . .	102 KIAS
2000 Lbs . . . . .	88 KIAS
Maximum Demonstrated Crosswind Velocity:	
Takeoff or Landing . . . . .	15 KNOTS

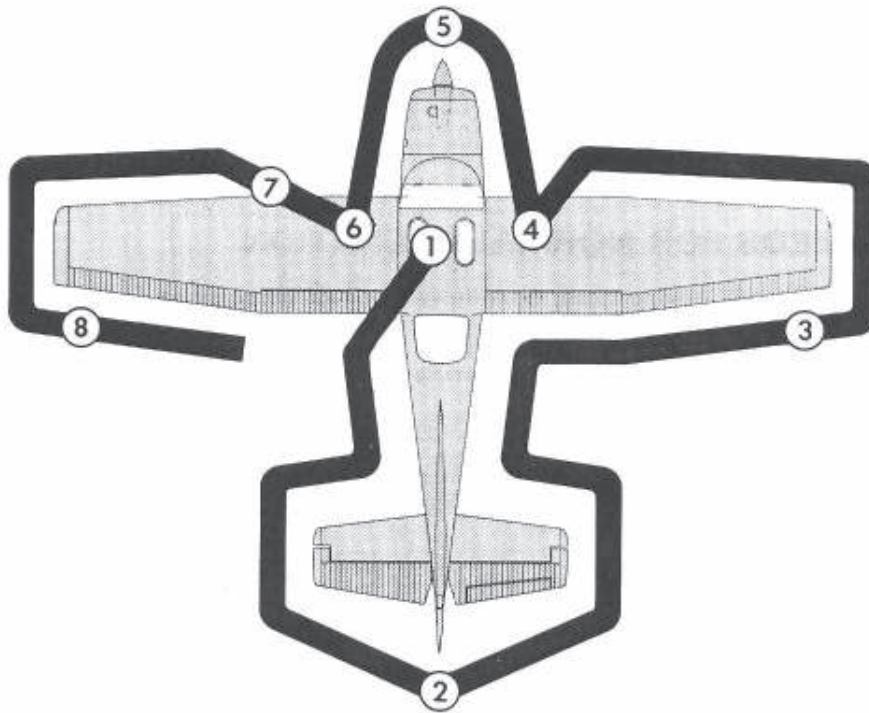

NOTE

Visually check airplane for general condition during walk-around inspection. Use of the refueling steps and assist handles (if installed) will simplify access to the upper wing surfaces for visual checks and refueling operations. In cold weather, remove even small accumulations of frost, ice or snow from wing, tail and control surfaces. Also, make sure that control surfaces contain no internal accumulations of ice or debris. Prior to flight, check that pitot heater (if installed) is warm to touch within 30 seconds with battery and pitot heat switches on. If a night flight is planned, check operation of all lights, and make sure a flashlight is available.

Figure 4-1. Preflight Inspection

## CHECKLIST PROCEDURES

### PREFLIGHT INSPECTION

#### ① CABIN

1. Pilot's Operating Handbook -- AVAILABLE IN THE AIRPLANE.
2. Parking Brake -- SET.
3. Control Wheel Lock -- REMOVE.
4. Ignition Switch -- OFF.
5. Master Switch -- ON.

#### WARNING

When turning on the master switch, using an external power source, or pulling the propeller through by hand, treat the propeller as if the ignition switch were on. Do not stand, nor allow anyone else to stand, within the arc of the propeller, since a loose or broken wire, or a component malfunction, could cause the propeller to rotate.

6. Avionics Power Switch -- ON.
7. Avionics Cooling Fan -- CHECK AUDIBLY FOR OPERATION.
8. Avionics Power Switch -- OFF.
9. Low-Vacuum Warning Light -- CHECK ON.
10. Fuel Quantity Indicators -- CHECK QUANTITY.
11. Master Switch -- OFF.
12. Static Pressure Alternate Source Valve (if installed) -- OFF.
13. Fuel Selector Valve -- BOTH.
14. Baggage Door -- CHECK for security, lock with key if child's seat is to be occupied.

#### ② EMPENNAGE

1. Rudder Gust Lock -- REMOVE.
2. Tail Tie-Down -- DISCONNECT.
3. Control Surfaces -- CHECK freedom of movement and security.

#### ③ RIGHT WING Trailing Edge

1. Aileron -- CHECK freedom of movement and security.

#### ④ RIGHT WING

1. Wing Tie-Down -- DISCONNECT.

2. Fuel Tank Vent Opening -- CHECK for stoppage.
3. Main Wheel Tire -- CHECK for proper inflation.
4. Fuel Tank Sump Quick-Drain Valve -- DRAIN at least a cupful of fuel (using sampler cup) to check for water, sediment, and proper fuel grade before first flight of day and after each refueling. If water is observed, take further samples until clear and then gently rock wings and lower tail to ground to move any additional contaminants to the sampling points. Take repeated samples from all fuel drain points until all contamination has been removed.
5. Fuel Quantity -- CHECK VISUALLY for desired level.
6. Fuel Filler Cap -- SECURE and vent unobstructed.

⑤ NOSE

1. Right Static Source Opening -- CHECK for stoppage.
2. Propeller and Spinner -- CHECK for nicks, security and oil leaks.
3. Engine Cooling Air Inlets -- CLEAR of obstructions.
4. Landing Lights -- CHECK for condition and cleanliness.
5. Carburetor Air Filter -- CHECK for restrictions by dust or other foreign matter.
6. Nose Wheel Strut and Tire -- CHECK for proper inflation.
7. Nose Tie-Down -- DISCONNECT.
8. Engine Oil Filler Cap -- CHECK secure.
9. Engine Oil Dipstick -- CHECK oil level, then check dipstick SECURE. Do not operate with less than nine quarts. Fill to twelve quarts for extended flight.
10. Fuel Strainer Drain Knob -- PULL OUT for at least four seconds to clear strainer of possible water and sediment before first flight of day and after each refueling. Return drain knob full in and check strainer drain CLOSED. If water is observed, perform further draining at all fuel drain points until clear and then gently rock wings and lower tail to ground to move any additional contaminants to the sampling points. Take repeated samples from all fuel drain points until all contamination has been removed.
11. Left Static Source Opening -- CHECK for stoppage.

⑥ LEFT WING

1. Fuel Quantity -- CHECK VISUALLY for desired level.
2. Fuel Filler Cap -- SECURE and vent unobstructed.
3. Fuel Tank Sump Quick-Drain Valve -- DRAIN at least a cupful of fuel (using sampler cup) to check for water, sediment, and proper fuel grade before first flight of day and after each refueling. If water is observed, take further samples until clear and then gently rock wings and lower tail to the ground to move any additional contaminants to the sampling points. Take repeated samples from all fuel drain points until all contamination has been removed.

4. Main Wheel Tire -- CHECK for proper inflation.

⑦ LEFT WING Leading Edge

1. Pitot Tube Cover -- REMOVE and check opening for stoppage.
2. Fuel Tank Vent Opening -- CHECK for stoppage.
3. Stall Warning Vane -- CHECK for freedom of movement while master switch is turned ON (horn should sound when vane is pushed upward).
4. Wing Tie-Down -- DISCONNECT.

⑧ LEFT WING Trailing Edge

1. Aileron -- CHECK freedom of movement and security.

## BEFORE STARTING ENGINE

1. Preflight Inspection -- COMPLETE.
2. Passenger Briefing -- COMPLETE.
3. Seats, Seat Belts, Shoulder Harnesses -- ADJUST and LOCK.
4. Brakes -- TEST and SET.
5. Avionics Power Switch -- OFF.

CAUTION

The avionics power switch must be OFF during engine start to prevent possible damage to avionics.

6. Electrical Equipment -- OFF.
7. Circuit Breakers -- CHECK IN.
8. Autopilot (if installed) -- OFF.
9. Cowl Flaps -- OPEN (move lever out of locking hole to reposition).
10. Fuel Selector Valve -- BOTH.

## STARTING ENGINE

1. Prime -- AS REQUIRED.
2. Carburetor Heat -- COLD.
3. Throttle -- OPEN 1/2 INCH.
4. Propeller -- HIGH RPM.
5. Mixture -- RICH.
6. Propeller Area -- CLEAR.
7. Master Switch -- ON.
8. Ignition Switch -- START (release when engine starts).

**NOTE**

If engine has been overprimed, start with throttle 1/4 to 1/2 open. Reduce throttle to idle when engine fires.

9. Oil Pressure -- CHECK.
10. Starter -- CHECK DISENGAGED (if starter were to remain engaged, ammeter would indicate full-scale charge with engine running at 1000 RPM).
11. Avionics Power Switch -- ON.
12. Navigation Lights and Flashing Beacon -- ON as required.
13. Radios -- ON.

**BEFORE TAKEOFF**

1. Parking Brake -- SET.
2. Seats, Seat Belts, Shoulder Harnesses -- CHECK SECURE.
3. Cabin Doors -- CLOSED and LOCKED.
4. Flight Controls -- FREE and CORRECT.
5. Flight Instruments -- CHECK and SET.

**CAUTION**

The directional indicator should be rechecked during engine runup to avoid compass deviation errors which may occur below 1200 RPM.

6. Primer -- LOCKED.
7. Fuel Quantity -- CHECK.
8. Mixture -- RICH.
9. Fuel Selector Valve -- RECHECK BOTH.
10. Elevator and Rudder Trim -- SET for takeoff.
11. Throttle -- 1700 RPM.
  - a. Magnetos -- CHECK (RPM drop should not exceed 150 RPM on either magneto or 50 RPM differential between magnetos).
  - b. Carburetor Heat -- CHECK (for RPM drop).
  - c. Propeller -- CYCLE from high to low RPM; return to high RPM (full in).
  - d. Suction Gage -- CHECK.
  - e. Engine Instruments and Ammeter -- CHECK.
12. Throttle -- 800 - 1000 RPM.
13. Throttle Friction Lock -- ADJUST.
14. Electric Trim (if installed) -- PREFLIGHT TEST (See Section 9).
15. Strobe Lights (if installed) -- AS DESIRED.
16. Radios and Avionics -- SET.
17. Autopilot (if installed) -- OFF.
18. Wing Flaps -- SET for takeoff (see Takeoff checklists).
19. Cowl Flaps -- OPEN.
20. Parking Brake -- RELEASE.



## TAKEOFF

### NORMAL TAKEOFF

1. Wing Flaps -- 0° - 20° .
2. Carburetor Heat -- COLD.
3. Power -- FULL THROTTLE and 2400 RPM.
4. Mixture -- FULL RICH (mixture may be leaned above 5000 feet for smooth operation).
5. Elevator Control -- LIFT NOSE WHEEL at 50 KIAS.
6. Climb Speed -- 70 KIAS (flaps 20°).  
80 KIAS (flaps UP).
7. Wing Flaps -- RETRACT.

### SHORT FIELD TAKEOFF

1. Wing Flaps -- 20°.
2. Carburetor Heat -- COLD.
3. Brakes -- APPLY.
4. Power -- FULL THROTTLE and 2400 RPM.
5. Mixture -- FULL RICH (mixture may be leaned above 5000 feet for smooth operation).
6. Brakes -- RELEASE.
7. Elevator Control -- MAINTAIN SLIGHTLY TAIL LOW ATTITUDE.
8. Climb Speed -- 59 KIAS (until all obstacles are cleared).
9. Wing Flaps -- RETRACT slowly after reaching 70 KIAS.

## ENROUTE CLIMB

### NORMAL CLIMB

1. Airspeed -- 85-95 KIAS.
2. Power -- 23 INCHES Hg or FULL THROTTLE (whichever is less) and 2400 RPM.
3. Fuel Selector Valve -- BOTH.
4. Mixture -- FULL RICH (mixture may be leaned above 5000 feet for smooth engine operation).
5. Cowl Flaps -- OPEN as required.

### MAXIMUM PERFORMANCE CLIMB

1. Airspeed -- 81 KIAS at sea level to 75 KIAS at 10,000 feet.
2. Power -- FULL THROTTLE and 2400 RPM.
3. Fuel Selector Valve -- BOTH.

4. Mixture -- FULL RICH (mixture may be leaned above 5000 feet for smooth engine operation).
5. Cowl Flaps -- FULL OPEN.

## CRUISE

1. Power -- 15-23 INCHES Hg, 2100-2400 RPM (no more than 75% power).
2. Elevator and Rudder Trim -- ADJUST.
3. Mixture -- LEAN.
4. Cowl Flaps -- CLOSED.

## DESCENT

1. Fuel Selector Valve -- BOTH.
2. Power -- AS DESIRED.
3. Mixture -- ENRICHEN as required.
4. Carburetor Heat -- FULL HEAT AS REQUIRED to prevent carburetor icing.
5. Cowl Flaps -- CLOSED.
6. Wing Flaps -- AS DESIRED (0° - 10° below 140 KIAS, 10° - 20° below 120 KIAS, 20° - FULL below 95 KIAS).

## BEFORE LANDING

1. Seats, Seat Belts, Shoulder Harnesses -- SECURE.
2. Fuel Selector Valve -- BOTH.
3. Mixture -- RICH.
4. Propeller -- HIGH RPM.
5. Carburetor Heat -- ON (apply full heat before reducing power).
6. Autopilot (if installed) -- OFF.

## LANDING

### NORMAL LANDING

1. Airspeed -- 70-80 KIAS (flaps UP).
2. Wing Flaps -- AS DESIRED (0° - 10° below 140 KIAS, 10° - 20° below 120 KIAS, 20° - FULL below 95 KIAS).
3. Airspeed -- 60-70 KIAS (flaps DOWN).
4. Trim -- ADJUST.
5. Touchdown -- MAIN WHEELS FIRST.
6. Landing Roll -- LOWER NOSE WHEEL GENTLY.
7. Braking -- MINIMUM REQUIRED.

### SHORT FIELD LANDING

1. Airspeed -- 70-80 KIAS (flaps UP).
2. Wing Flaps -- FULL (below 95 KIAS).
3. Airspeed -- MAINTAIN 61 KIAS.
4. Trim -- ADJUST.
5. Power -- REDUCE to idle as obstacle is cleared.
6. Touchdown -- MAIN WHEELS FIRST.
7. Brakes -- APPLY HEAVILY.
8. Wing Flaps -- RETRACT for maximum brake effectiveness.

### BALKED LANDING

1. Power -- FULL THROTTLE and 2400 RPM.
2. Carburetor Heat -- COLD.
3. Wing Flaps -- RETRACT to 20°.
4. Climb Speed -- 55 KIAS.
5. Wing Flaps -- RETRACT slowly after reaching 70 KIAS.
6. Cowl Flaps -- OPEN.

### AFTER LANDING

1. Carburetor Heat -- COLD.
2. Wing Flaps -- UP.
3. Cowl Flaps -- OPEN.

### SECURING AIRPLANE

1. Parking Brake -- SET.
2. Throttle -- IDLE.
3. Avionics Power Switch, Electrical Equipment -- OFF.
4. Mixture -- IDLE CUT-OFF (pulled full out).
5. Ignition Switch -- OFF.
6. Master Switch -- OFF.
7. Control Lock -- INSTALL.
8. Cowl Flaps -- CLOSE.
9. Fuel Selector Valve -- RIGHT or LEFT to prevent crossfeeding.

## AMPLIFIED PROCEDURES

### PREFLIGHT INSPECTION

The Preflight Inspection, described in figure 4-1 and adjacent checklist, is recommended for the first flight of the day. Inspection procedures for subsequent flights are normally limited to brief checks of control surface hinges, fuel and oil quantity, and security of fuel and oil filler caps and draining of the fuel strainer, and fuel tank sumps. If the airplane has been in extended storage, has had recent major maintenance, or has been operated from marginal airports, a more extensive exterior inspection is recommended.

After major maintenance has been performed, the flight and trim tab controls should be double-checked for free and correct movement and security. The security of all inspection plates on the airplane should be checked following periodic inspections. If the airplane has been waxed or polished, check the external static pressure source holes for stoppage.

If the airplane has been exposed to much ground handling in a crowded hangar, it should be checked for dents and scratches on wings, fuselage, and tail surfaces, as well as damage to navigation and anti-collision lights, and avionics antennas.

Outside storage for long periods may result in dust and dirt accumulation on the induction air filter, obstructions in airspeed system lines, and condensation in fuel tanks. If any water is detected in the fuel system, the fuel tank sump quick-drain valves, fuel selector valve drain, and fuel strainer drain should all be thoroughly drained again. Then, the wings should be gently rocked and the tail lowered to the ground to move any further contaminants to the sampling points. Repeated samples should be taken from all drain points until all contamination has been removed. If, after repeated sampling, evidence of contamination still exists, the fuel tanks should be completely drained and the fuel system cleaned. Outside storage in windy or gusty areas, or tie-down adjacent to taxiing airplanes, calls for special attention to control surface stops, hinges, and brackets to detect the presence of wind damage.

If the airplane has been operated from muddy fields or in snow or slush, check the main and nose gear wheel fairings for obstructions and cleanliness. Operation from a gravel or cinder field will require extra attention to propeller tips and abrasion on leading edges of the horizontal tail. Stone damage to the propeller can seriously reduce the fatigue life of the blades.

Airplanes that are operated from rough fields, especially at high altitudes, are subjected to abnormal landing gear abuse. Frequently check all components of the landing gear, shock strut, tires, and brakes. If the

shock strut is insufficiently extended, undue landing and taxi loads will be subjected on the airplane structure.

To prevent loss of fuel in flight, make sure the fuel tank filler caps are tightly sealed after any fuel system check or servicing. Fuel system vents should also be inspected for obstructions, ice or water, especially after exposure to cold, wet weather.

## STARTING ENGINE

Ordinarily the engine starts easily with one or two strokes of the primer in warm temperatures to six strokes in cold weather with the throttle open approximately 1/2 inch. In extremely cold temperatures, it may be necessary to continue priming while cranking. Weak intermittent firing followed by puffs of black smoke from the exhaust stack indicates overpriming or flooding. Excess fuel can be cleared from the combustion chambers by the following procedure: Set the mixture control full lean and the throttle full open; then crank the engine through several revolutions with the starter. Repeat the starting procedure without any additional priming.

If the engine is underprimed (most likely in cold weather with a cold engine) it will not fire at all. Additional priming will be necessary for the next starting attempt. As soon as the cylinders begin to fire, open the throttle slightly to keep it running.

If prolonged cranking is necessary, allow the starter motor to cool at frequent intervals, since excessive heat may damage the armature.

After starting, if the oil gage does not begin to show pressure within 30 seconds in the summertime and about twice that long in very cold weather, stop engine and investigate. Lack of oil pressure can cause serious engine damage. After starting, avoid the use of carburetor heat unless icing conditions prevail.

### NOTE

Additional details concerning cold weather starting and operation may be found under COLD WEATHER OPERATION paragraphs in this section.

After the completion of normal engine starting procedures, it is a good practice to verify that the engine starter has disengaged. If the starter contactor were to stick closed, causing the starter to remain engaged, an excessively high charge indication (full scale at 1000 RPM) would be evident on the ammeter. In this event, immediately shut down the engine and take corrective action prior to flight.

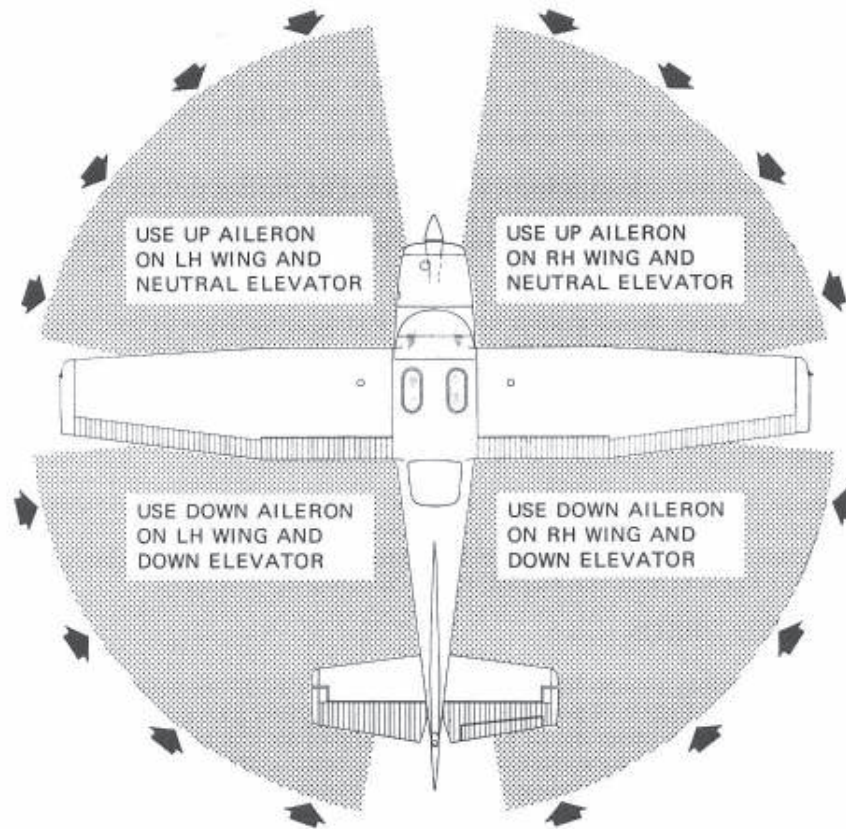

CODE  
WIND DIRECTION →

NOTE

Strong quartering tail winds require caution. Avoid sudden bursts of the throttle and sharp braking when the airplane is in this attitude. Use the steerable nose wheel and rudder to maintain direction.

Figure 4-2. Taxiing Diagram

## TAXIING

When taxiing, it is important that speed and use of brakes be held to a minimum and that all controls be utilized (see Taxiing Diagram, figure 4-2) to maintain directional control and balance.

The carburetor heat control knob should be pushed full in during all ground operations unless heat is absolutely necessary for smooth engine operation. When the knob is pulled out to the heat position, air entering the engine is not filtered.

Taxiing over loose gravel or cinders should be done at low engine speed to avoid abrasion and stone damage to the propeller tips.

## BEFORE TAKEOFF

### WARM-UP

Since the engine is closely cowled for efficient in-flight cooling, precautions should be taken to avoid overheating on the ground. Full power checks on the ground are not recommended unless the pilot has good reason to suspect that the engine is not turning up properly.

### MAGNETO CHECK

The magneto check should be made at 1700 RPM as follows. Move ignition switch first to R position and note RPM. Next move switch back to BOTH to clear the other set of plugs. Then move switch to the L position, note RPM and return the switch to the BOTH position. RPM drop should not exceed 150 RPM on either magneto or show greater than 50 RPM differential between magnetos. If there is a doubt concerning operation of the ignition system, RPM checks at higher engine speeds will usually confirm whether a deficiency exists.

An absence of RPM drop may be an indication of faulty grounding of one side of the ignition system or should be cause for suspicion that the magneto timing is set in advance of the setting specified.

### ALTERNATOR CHECK

Prior to flights where verification of proper alternator and alternator control unit operation is essential (such as night or instrument flights), a positive verification can be made by loading the electrical system momentarily (3 to 5 seconds) with the landing light during the engine runup (1700 RPM). The ammeter will remain within a needle width of the initial reading if the alternator and alternator control unit are operating properly.

## TAKEOFF

### POWER CHECK

It is important to check takeoff power early in the takeoff roll. Any sign of rough engine operation or sluggish engine acceleration is good cause for discontinuing the takeoff.

Full power runups over loose gravel are especially harmful to propeller tips. When takeoffs must be made over a gravel surface, it is very important that the throttle be advanced slowly. This allows the airplane to start rolling before high RPM is developed, and the gravel will be blown back of the propeller rather than pulled into it. When unavoidable small dents appear in the propeller blades they should be corrected immediately as described in Section 8 under Propeller Care.

After full power is applied, adjust the throttle friction lock clockwise to prevent the throttle from creeping from a maximum power position. Similar friction lock adjustment should be made as required in other flight conditions to maintain a fixed throttle setting.

### WING FLAP SETTINGS

Normal takeoffs are accomplished with wing flaps 0° to 20°. Using 20° wing flaps reduces the ground roll and total distance over an obstacle by approximately 20 per cent. Flap deflections greater than 20° are not approved for takeoff.

If 20° wing flaps are used for takeoff, they should be left down until all obstacles are cleared and a safe flap retraction speed of 70 KIAS is reached. To clear an obstacle with wing flaps 20°, an obstacle clearance speed of 59 KIAS should be used.

Soft field takeoffs are performed with 20° flaps by lifting the airplane off the ground as soon as practical in a slightly tail-low attitude. If no obstacles are ahead, the airplane should be leveled off immediately to accelerate to a safer climb speed.

With wing flaps retracted and no obstructions ahead, a climb-out speed of 80 KIAS would be most efficient.

### CROSSWIND TAKEOFF

Takeoffs into strong crosswinds normally are performed with the minimum flap setting necessary for the field length, to minimize the drift angle immediately after takeoff. With the ailerons partially deflected into the wind, the airplane is accelerated to a speed slightly higher than



normal, and then pulled off abruptly to prevent possible settling back to the runway while drifting. When clear of the ground, make a coordinated turn into the wind to correct for drift.

## ENROUTE CLIMB

Normal climbs are performed at 85-95 KIAS with flaps up, 23 In. Hg. or full throttle (whichever is less) and 2400 RPM for the best combination of engine cooling, rate of climb and forward visibility. If it is necessary to climb rapidly to clear mountains or reach favorable winds at high altitudes, the best rate-of-climb speed should be used with maximum power. This speed is 81 KIAS at sea level, decreasing to 75 KIAS at 10,000 feet.

If an obstruction ahead requires a steep climb angle, a best angle-of-climb speed should be used with flaps up and maximum power. This speed is 59 KIAS at sea level, increasing to 66 KIAS at 10,000 feet.

The mixture should be full rich during climb at altitudes up to 5000 feet. Above 5000 feet, the mixture may be leaned for smooth engine operation and increased power.

## CRUISE

Normal cruising is performed between 55% and 75% power. The corresponding power settings and fuel consumption for various altitudes can be determined by using your Cessna Power Computer or the data in Section 5.

### NOTE

Cruising should be done at 75% power as much as practicable until a total of 50 hours has accumulated or oil consumption has stabilized. This is to ensure proper seating of the rings and is applicable to new engines, and engines in service following cylinder replacement or top overhaul of one or more cylinders.

The Cruise Performance Table, figure 4-3, illustrates the true airspeed and nautical miles per gallon during cruise for various altitudes and percent powers. This table should be used as a guide, along with the available winds aloft information, to determine the most favorable altitudes and power setting for a given trip. The selection of cruise altitude on the basis

ALTITUDE	75% POWER		65% POWER		55% POWER	
	KTAS	NMPG	KTAS	NMPG	KTAS	NMPG
4000 Feet	137	10.6	129	11.6	118	12.5
6000 Feet	139	10.8	131	11.8	120	12.6
8000 Feet	142	11.0	133	12.0	121	12.8
10,000 Feet	---	---	135	12.2	123	13.0
Standard Conditions					Zero Wind	

Figure 4-3. Cruise Performance Table

of the most favorable wind conditions and the use of low power settings are significant factors that should be considered on every trip to reduce fuel consumption.

For reduced noise levels, it is desirable to select the lowest RPM in the green arc range for a given percent power that will provide smooth engine operation. The cowl flaps should be opened, if necessary, to maintain the cylinder head temperature at approximately two-thirds of the normal operating range (green arc).

Cruise performance data in this handbook and on the power computer is based on a recommended lean mixture setting which may be established as follows:

1. Lean the mixture until the engine becomes rough.
2. Enrichen the mixture to obtain smooth engine operation; then further enrichen an equal amount.

For best fuel economy at 65% power or less, the engine may be operated at the leanest mixture that results in smooth engine operation. This will result in approximately 5% greater range than shown in this handbook accompanied by approximately a 3 knot decrease in speed.

Any change in altitude, power or carburetor heat will require a change in the recommended lean mixture setting and a recheck of the EGT setting (if installed).

Carburetor ice, as evidenced by an unexplained drop in manifold pressure, can be removed by application of full carburetor heat. Upon regaining the original manifold pressure indication (with heat off), use the minimum amount of heat (by trial and error) to prevent ice from forming. Since the heated air causes a richer mixture, readjust the mixture setting

MIXTURE DESCRIPTION	EXHAUST GAS TEMPERATURE
RECOMMENDED LEAN (Pilot's Operating Handbook and Power Computer)	50°F Rich of Peak EGT
BEST ECONOMY (65% Power or Less)	Peak EGT

Figure 4-4. EGT Table

when carburetor heat is to be used continuously in cruise flight.

The use of full carburetor heat is recommended during flight in very heavy rain to avoid the possibility of engine stoppage due to excessive water ingestion. The mixture setting should be readjusted for smoothest operation.

#### LEANING WITH A CESSNA ECONOMY MIXTURE INDICATOR (EGT)

Exhaust gas temperature (EGT) as shown on the optional Cessna Economy Mixture Indicator may be used as an aid for mixture leaning in cruising flight at 75% power or less. To adjust the mixture, using this indicator, lean to establish the peak EGT as a reference point and then enrich the mixture by a desired increment based on data in figure 4-4.

Continuous operation at peak EGT is authorized only at 65% power or less. This best economy mixture setting results in approximately 5% greater range than shown in this handbook accompanied by approximately a 3 knot decrease in speed.

#### NOTE

Operation on the lean side of peak EGT is not approved.

When leaning the mixture under some conditions, engine roughness may occur before peak EGT is reached. In this case, use the EGT corresponding to the onset of roughness as the reference point instead of peak EGT.

## STALLS

The stall characteristics are conventional and aural warning is

provided by a stall warning horn which sounds between 5 and 10 knots above the stall in all configurations.

Power-off stall speeds at maximum weight for both forward and aft C.G. are presented in Section 5.

## LANDING

### NORMAL LANDING

Landings should be made on the main wheels first to reduce the landing speed and the subsequent need for braking in the landing roll. The nose wheel is lowered gently to the runway after the speed has diminished to avoid unnecessary nose gear load. This procedure is especially important in rough field landings.

### SHORT FIELD LANDING

For a short field landing, make a power-off approach at 61 KIAS with full flaps and land on the main wheels first. Immediately after touchdown, lower the nose gear to the ground and apply heavy braking as required. For maximum brake effectiveness after all three wheels are on the ground, retract the flaps, hold full nose up elevator and apply maximum possible brake pressure without sliding the tires.

### CROSSWIND LANDING

When landing in a strong crosswind, use the minimum flap setting required for the field length. Although the crab or combination method of drift correction may be used, the wing-low method gives the best control. After touchdown, hold a straight course with the steerable nose wheel and occasional braking if necessary.

### BALKED LANDING

In a bailed landing (go-around) climb, the wing flap setting should be reduced to 20° immediately after full power is applied. After all obstacles are cleared and a safe altitude and airspeed are obtained, the wing flaps should be retracted.

## COLD WEATHER OPERATION

Special consideration should be given to the operation of the airplane fuel system during the winter season or prior to any flight in cold temperatures. Proper preflight draining of the fuel system is especially important

and will eliminate any free water accumulation. The use of additives such as isopropyl alcohol or ethylene glycol monomethyl ether may also be desirable. Refer to Section 8 for information on the proper use of additives.

Cold weather often causes conditions which require special care during airplane operations. Even small accumulations of frost, ice, or snow must be removed, particularly from wing, tail and all control surfaces to assure satisfactory flight performance and handling. Also, control surfaces must be free of any internal accumulations of ice or snow.

If snow or slush covers the takeoff surface, allowance must be made for takeoff distances which will be increasingly extended as the snow or slush depth increases. The depth and consistency of this cover can, in fact, prevent takeoff in many instances.

## STARTING

Prior to starting on cold mornings, it is advisable to pull the propeller through several times by hand to "break loose" or "limber" the oil, thus conserving battery energy.

### WARNING

When pulling the propeller through by hand, treat it as if the ignition switch is turned on. A loose or broken ground wire on either magneto could cause the engine to fire.

In extremely cold (-18°C and lower) weather, the use of an external preheater and an external power source are recommended whenever possible to obtain positive starting and to reduce wear and abuse to the engine and the electrical system. Pre-heat will thaw the oil trapped in the oil cooler, which probably will be congealed prior to starting in extremely cold temperatures. When using an external power source, the position of the master switch is important. Refer to Section 9, Supplements, for Ground Service Plug Receptacle operating details.

Cold weather starting procedures are as follows:

#### With Preheat:

1. Parking Brake -- SET.
2. Ignition Switch -- OFF.
3. Throttle -- CLOSED.
4. Mixture -- IDLE CUT-OFF.
5. Prime -- 4 to 8 STROKES as the propeller is being turned over by hand (use heavy strokes of primer for best atomization of fuel.)

CAUTION

Caution should be used to ensure the brakes are set or a qualified person is at the controls.

6. Primer -- LOCK.
7. Throttle -- OPEN 1/2 INCH.
8. Propeller -- HIGH RPM.
9. Mixture -- FULL RICH.
10. Propeller Area -- CLEAR.
11. Master Switch -- ON.
12. Ignition Switch -- START (release to BOTH when engine starts).
13. Carburetor Heat -- ON after engine has started, and leave on until the engine is running smoothly.
14. Oil Pressure -- CHECK.

**Without Preheat:**

1. Parking Brake -- SET.
2. Ignition Switch -- OFF.
3. Throttle -- CLOSED.
4. Mixture -- IDLE CUT-OFF.
5. Prime -- 6 to 8 STROKES as the propeller is being turned over by hand. Leave the primer charged and ready for a stroke

CAUTION

Caution should be used to ensure the brakes are set or a qualified person is at the controls.

6. Propeller -- HIGH RPM.
7. Mixture -- FULL RICH.
8. Propeller Area -- CLEAR.
9. Master Switch -- ON.
10. Ignition Switch -- START.
11. Pump throttle rapidly to full open twice. Return to 1/2 inch open position.
12. Release ignition switch to BOTH when engine starts.
13. Continue to prime engine until it is running smoothly, or alternately, pump the throttle rapidly over first 1/4 of total travel.
14. Oil Pressure -- CHECK.
15. Pull carburetor heat knob full on after engine has started. Leave on until engine is running smoothly.
16. Primer -- LOCK.

**NOTE**

If the engine does not start during the first few attempts, or if engine firing diminishes in strength, it is probable that the spark plugs have been frosted over. Preheat must be used before another start is attempted.

**CAUTION**

Pumping the throttle may cause raw fuel to accumulate in the intake air duct, creating a fire hazard in the event of a backfire. If this occurs, maintain a cranking action to suck flames into the engine. An outside attendant with a fire extinguisher is advised for cold starts without preheat.

**OPERATION**

During cold weather operations, no indication will be apparent on the oil temperature gage prior to takeoff if outside air temperatures are very cold. After a suitable warm-up period (2 to 5 minutes at 1000 RPM), accelerate the engine several times to higher engine RPM. If the engine accelerates smoothly and the oil pressure remains normal and steady, the airplane is ready for takeoff.

Rough engine operation in cold weather can be caused by a combination of an inherently leaner mixture due to the dense air and poor vaporization and distribution of the fuel-air mixture to the cylinders. The effects of these conditions are especially noticeable during operation on one magneto in ground checks where only one spark plug fires in each cylinder.

For optimum operation of the engine in cold weather, the appropriate use of carburetor heat is recommended. The following procedures are indicated as a guideline:

1. Use carburetor heat during engine warm-up and ground check. Full carburetor heat may be required for temperatures below -12°C whereas partial heat could be used in temperatures between -12°C and 4°C.
2. Use the minimum carburetor heat required for smooth operation in take-off, climb, and cruise.

**NOTE**

Care should be exercised when using partial carburetor heat to avoid icing. Partial heat may raise the carburetor air temperature to the 0° to 21°C range where icing is possible under certain atmospheric conditions.

3. If the airplane is equipped with a carburetor air temperature gage, it can be used as a reference in maintaining carburetor air temperature at or slightly above the top of the yellow arc by application of carburetor heat.

## HOT WEATHER OPERATION

The general warm temperature starting information in this section is appropriate. Avoid prolonged engine operation on the ground.

## NOISE CHARACTERISTICS

Increased emphasis on improving the quality of our environment requires renewed effort on the part of all pilots to minimize the effect of airplane noise on the public.

We, as pilots, can demonstrate our concern for environmental improvement, by application of the following suggested procedures, and thereby tend to build public support for aviation:

1. Pilots operating aircraft under VFR over outdoor assemblies of persons, recreational and park areas, and other noise-sensitive areas should make every effort to fly not less than 2000 feet above the surface, weather permitting, even though flight at a lower level may be consistent with the provisions of government regulations.
2. During departure from or approach to an airport, climb after takeoff and descent for landing should be made so as to avoid prolonged flight at low altitude near noise-sensitive areas.

### NOTE

The above recommended procedures do not apply where they would conflict with Air Traffic Control clearances or instructions, or where, in the pilot's judgment, an altitude of less than 2000 feet is necessary for him to adequately exercise his duty to see and avoid other aircraft.

The certificated noise level for the Model 182R at 3100 pounds maximum weight is 69.1 dB(A). No determination has been made by the Federal Aviation Administration that the noise levels of this airplane are or should be acceptable or unacceptable for operation at, into, or out of, any airport.



# SECTION 5 PERFORMANCE

## TABLE OF CONTENTS

	Page
Introduction . . . . .	5-3
Use of Performance Charts . . . . .	5-3
Sample Problem . . . . .	5-3
Takeoff . . . . .	5-4
Cruise . . . . .	5-5
Fuel Required . . . . .	5-5
Landing . . . . .	5-7
Demonstrated Operating Temperature . . . . .	5-7
Figure 5-1, Airspeed Calibration - Normal Static Source . . . . .	5-9
Airspeed Calibration - Alternate Static Source . . . . .	5-10
Figure 5-2, Temperature Conversion Chart . . . . .	5-11
Figure 5-3, Stall Speeds . . . . .	5-12
Figure 5-4, Wind Components . . . . .	5-13
Figure 5-5, Takeoff Distance - 3100 Lbs . . . . .	5-14
Takeoff Distance - 2800 Lbs and 2500 Lbs . . . . .	5-15
Figure 5-6, Maximum Rate Of Climb . . . . .	5-16
Figure 5-7, Time, Fuel, And Distance To Climb - Maximum Rate of Climb . . . . .	5-17
Time, Fuel, and Distance to Climb - Normal Climb . . . . .	5-18
Figure 5-8, Cruise Performance - 2000 Feet . . . . .	5-19
Cruise Performance - 4000 Feet . . . . .	5-20
Cruise Performance - 6000 Feet . . . . .	5-21
Cruise Performance - 8000 Feet . . . . .	5-22
Cruise Performance - 10,000 Feet . . . . .	5-23
Cruise Performance - 12,000 Feet . . . . .	5-24
Cruise Performance - 14,000 Feet . . . . .	5-25
Figure 5-9, Range Profile - 65 Gallons Fuel . . . . .	5-26
Range Profile - 88 Gallons Fuel . . . . .	5-27
Figure 5-10, Endurance Profile - 65 Gallons Fuel . . . . .	5-28
Endurance Profile - 88 Gallons Fuel . . . . .	5-29
Figure 5-11, Landing Distance . . . . .	5-30

## INTRODUCTION

Performance data charts on the following pages are presented so that you may know what to expect from the airplane under various conditions, and also, to facilitate the planning of flights in detail and with reasonable accuracy. The data in the charts has been computed from actual flight tests with the airplane and engine in good condition and using average piloting techniques.

It should be noted that the performance information presented in the range and endurance profile charts allows for 45 minutes reserve fuel at the specified cruise power. Fuel flow data for cruise is based on the recommended lean mixture setting. Some indeterminate variables such as mixture leaning technique, fuel metering characteristics, engine and propeller condition, and air turbulence may account for variations of 10% or more in range and endurance. Therefore, it is important to utilize all available information to estimate the fuel required for the particular flight.

Cruise speeds are shown for an airplane equipped with optional speed-fairings, which increase the speeds by approximately 3 knots. There is a corresponding difference in range, while other performance figures are unchanged when speed fairings are installed.

## USE OF PERFORMANCE CHARTS

Performance data is presented in tabular or graphical form to illustrate the effect of different variables. Sufficiently detailed information is provided in the tables so that conservative values can be selected and used to determine the particular performance figure with reasonable accuracy.

## SAMPLE PROBLEM

The following sample flight problem utilizes information from the various charts to determine the predicted performance data for a typical flight. The following information is known:

### AIRPLANE CONFIGURATION

Takeoff weight	3050 Pounds
Usable fuel	65 Gallons

### TAKEOFF CONDITIONS

Field pressure altitude	1500 Feet
Temperature	28°C (16°C above standard)
Wind component along runway	12 Knot Headwind
Field length	3500 Feet

SECTION 5  
PERFORMANCE

CESSNA  
MODEL 182R

CRUISE CONDITIONS

Total distance	450 Nautical Miles
Pressure altitude	7500 Feet
Temperature	16°C (16°C above standard)
Expected wind enroute	10 Knot Headwind

LANDING CONDITIONS

Field pressure altitude	2000 Feet
Temperature	25°C
Field length	3000 Feet

TAKEOFF

The takeoff distance chart, figure 5-5, should be consulted, keeping in mind that the distances shown are based on the short field technique. Conservative distances can be established by reading the chart at the next higher value of weight, altitude and temperature. For example, in this particular sample problem, the takeoff distance information presented for a weight of 3100 pounds, pressure altitude of 2000 feet and a temperature of 30°C should be used and results in the following:

Ground roll	1065 Feet
Total distance to clear a 50-foot obstacle	2035 Feet

These distances are well within the available takeoff field length. However, a correction for the effect of wind may be made based on Note 3 of the takeoff chart. The correction for a 12 knot headwind is:

$$\frac{12 \text{ Knots}}{9 \text{ Knots}} \times 10\% = 13\% \text{ Decrease}$$

This results in the following distances, corrected for wind:

Ground roll, zero wind	1065
Decrease in ground roll (1065 feet × 13%)	<u>138</u>
Corrected ground roll	927 Feet
Total distance to clear a 50-foot obstacle, zero wind	2035
Decrease in total distance (2035 feet × 13%)	<u>265</u>
Corrected total distance to clear 50-foot obstacle	1770 Feet

## CRUISE

The cruising altitude should be selected based on a consideration of trip length, winds aloft, and the airplane's performance. A cruising altitude and the expected wind enroute have been given for this sample problem. However, the power setting selection for cruise must be determined based on several considerations. These include the cruise performance characteristics presented in figure 5-8, the range profile charts presented in figure 5-9, and the endurance profile charts presented in figure 5-10.

The relationship between power and range is illustrated by the range profile charts. Considerable fuel savings and longer range result when lower power settings are used. For this sample problem, a cruise power of approximately 65% will be used.

The cruise performance chart for 8,000 feet pressure altitude is entered using 20°C above standard temperature. These values most nearly correspond to the planned altitude and expected temperature conditions. The power setting chosen is 2200 RPM and 21 inches of manifold pressure, which results in the following:

Power	65%
True airspeed	135 Knots
Cruise fuel flow	11.0 GPH

The power computer may be used to determine power and fuel consumption more accurately during the flight.

## FUEL REQUIRED

The total fuel requirement for the flight may be estimated using the performance information in figures 5-7 and 5-8. For this sample problem, figure 5-7 shows that a normal climb from 2000 feet to 8000 feet requires 3.5 gallons of fuel. The corresponding distance during the climb is 19 nautical miles. These values are for a standard temperature and are sufficiently accurate for most flight planning purposes. However, a further correction for the effect of temperature may be made as noted on the climb chart. The approximate effect of a non-standard temperature is to increase the time, fuel, and distance by 10% for each 10°C above standard temperature, due to the lower rate of climb. In this case, assuming a temperature 16°C above standard, the correction would be:

$$\frac{16^{\circ}\text{C}}{10^{\circ}\text{C}} \times 10\% = 16\% \text{ Increase}$$

With this factor included, the fuel estimate would be calculated as follows:

SECTION 5  
PERFORMANCE

CESSNA  
MODEL 182R

Fuel to climb, standard temperature	3.5
Increase due to non-standard temperature (3.5 × 16%)	<u>0.6</u>
Corrected fuel to climb	4.1 Gallons

Using a similar procedure for the distance during climb results in 22 nautical miles.

The resultant cruise distance is:

Total distance	450
Climb distance	<u>-22</u>
Cruise distance	428 Nautical Miles

With an expected 10 knot headwind, the ground speed for cruise is predicted to be:

135
<u>-10</u>
125 Knots

Therefore, the time required for the cruise portion of the trip is:

$$\frac{428 \text{ Nautical Miles}}{125 \text{ Knots}} = 3.4 \text{ Hours}$$

The fuel required for cruise is:

$$3.4 \text{ hours} \times 11.0 \text{ gallons/hour} = 37.4 \text{ Gallons}$$

A 45-minute reserve requires:

$$\frac{45}{60} \times 11.0 \text{ gallons/hour} = 8.3 \text{ Gallons}$$

The total estimated fuel required is as follows:

Engine start, taxi, and takeoff	1.7
Climb	4.1
Cruise	37.4
Reserve	<u>8.3</u>
Total fuel required	51.5 Gallons

Once the flight is underway, ground speed checks will provide a more accurate basis for estimating the time enroute and the corresponding fuel required to complete the trip with ample reserve.

### LANDING

A procedure similar to takeoff should be used for estimating the landing distance at the destination airport. Figure 5-11 presents landing distance information for the short field technique. The distances corresponding to 2000 feet pressure altitude and a temperature of 30°C are as follows:

Ground roll	670 Feet
Total distance to clear a 50-foot obstacle	1480 Feet

A correction for the effect of wind may be made based on Note 2 of the landing chart using the same procedure as outlined for takeoff.

### DEMONSTRATED OPERATING TEMPERATURE

Satisfactory engine cooling has been demonstrated for this airplane with an outside air temperature 23°C above standard. This is not to be considered as an operating limitation. Reference should be made to Section 2 for engine operating limitations.

## AIRSPEED CALIBRATION NORMAL STATIC SOURCE

**CONDITIONS:**

Power required for level flight or maximum power descent.

FLAPS UP														
KIAS	55	60	70	80	90	100	110	120	130	140	150	160	---	
KCAS	62	65	72	80	90	99	109	118	128	137	147	156	---	
FLAPS 20°														
KIAS	40	50	60	70	80	90	100	110	120	---	---	---	---	
KCAS	54	58	63	71	80	90	100	109	119	---	---	---	---	
FLAPS FULL														
KIAS	40	50	60	70	80	90	95	---	---	---	---	---	---	
KCAS	52	57	63	71	80	90	95	---	---	---	---	---	---	

Figure 5-1. Airspeed Calibration (Sheet 1 of 2)

**AIRSPED CALIBRATION  
ALTERNATE STATIC SOURCE**

**HEATER/VENTS AND WINDOWS CLOSED**

FLAPS UP											
NORMAL KIAS	60	70	80	90	100	110	120	130	140	150	160
ALTERNATE KIAS	60	71	82	92	103	113	123	133	143	153	163
FLAPS 20°											
NORMAL KIAS	50	60	70	80	90	100	110	120	---	---	---
ALTERNATE KIAS	49	60	71	82	92	102	113	123	---	---	---
FLAPS FULL											
NORMAL KIAS	40	50	60	70	80	90	95	---	---	---	---
ALTERNATE KIAS	44	48	60	71	81	90	95	---	---	---	---

**HEATER/VENTS OPEN AND WINDOWS CLOSED**

FLAPS UP											
NORMAL KIAS	60	70	80	90	100	110	120	130	140	150	160
ALTERNATE KIAS	60	69	79	90	100	110	120	130	140	150	160
FLAPS 20°											
NORMAL KIAS	50	60	70	80	90	100	110	120	---	---	---
ALTERNATE KIAS	47	58	68	78	89	100	110	120	---	---	---
FLAPS FULL											
NORMAL KIAS	40	50	60	70	80	90	95	---	---	---	---
ALTERNATE KIAS	44	47	57	67	77	86	91	---	---	---	---

Figure 5-1. Airspeed Calibration (Sheet 2 of 2)



### TEMPERATURE CONVERSION CHART

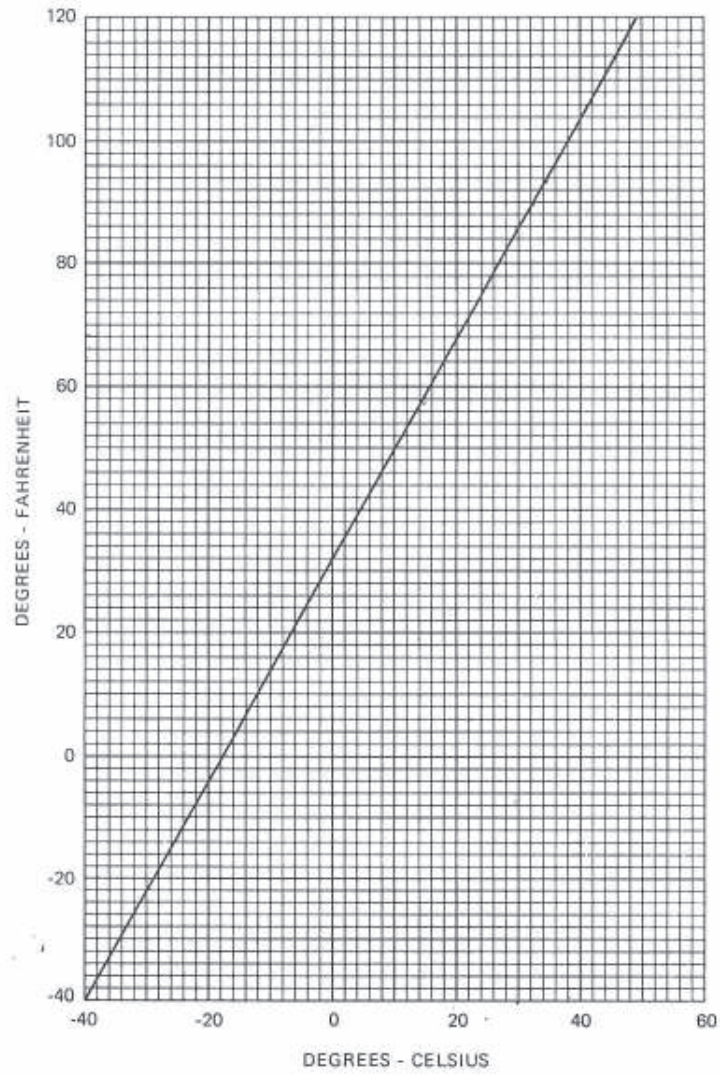

Figure 5-2. Temperature Conversion Chart

## STALL SPEEDS

CONDITIONS:  
Power Off

NOTES:

1. Altitude loss during a stall recovery may be as much as 250 feet.
2. KIAS values are approximate.

### MOST REARWARD CENTER OF GRAVITY

WEIGHT LBS	FLAP DEFLECTION	ANGLE OF BANK							
		0°		30°		45°		60°	
		KIAS	KCAS	KIAS	KCAS	KIAS	KCAS	KIAS	KCAS
3100	UP	50	54	54	58	60	64	71	76
	20°	42	50	45	54	50	60	59	71
	FULL	40	49	43	53	48	58	57	69

### MOST FORWARD CENTER OF GRAVITY

WEIGHT LBS	FLAP DEFLECTION	ANGLE OF BANK							
		0°		30°		45°		60°	
		KIAS	KCAS	KIAS	KCAS	KIAS	KCAS	KIAS	KCAS
3100	UP	50	56	54	60	60	67	71	79
	20°	42	52	45	56	50	62	59	74
	FULL	40	50	43	54	48	60	57	71

Figure 5-3. Stall Speeds

### WIND COMPONENTS

NOTE:  
Maximum demonstrated crosswind velocity is 15 knots (not a limitation).

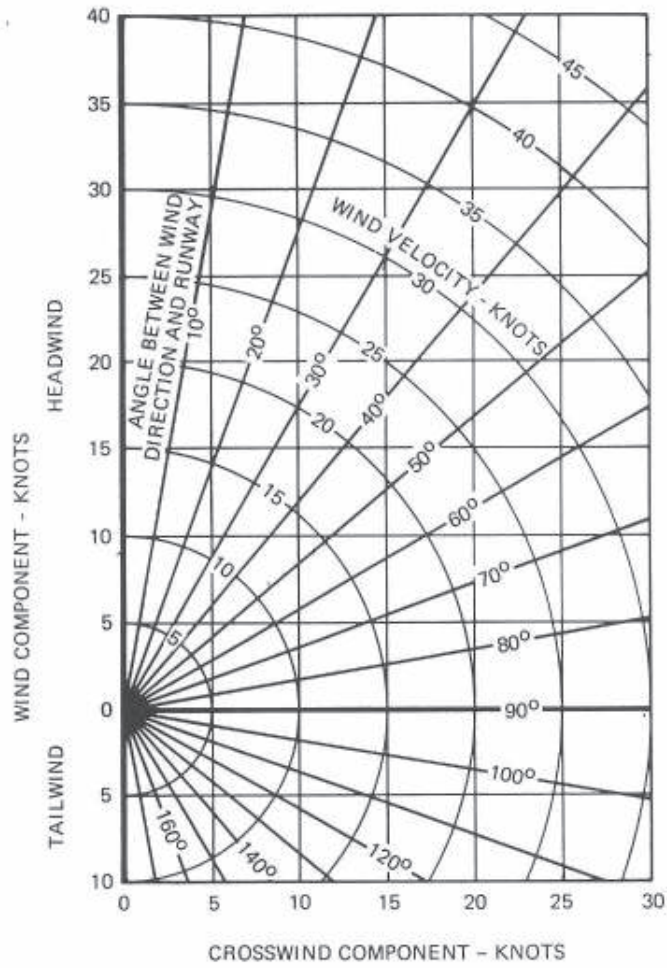

Figure 5-4. Wind Components

**TAKEOFF DISTANCE**  
**MAXIMUM WEIGHT 3100 LBS**  
**SHORT FIELD**

**CONDITIONS:**

Flaps 20°  
2400 RPM, Full Throttle and Mixture Set Prior to  
Brake Release  
Cowl Flaps Open  
Paved, Level, Dry Runway  
Zero Wind

**NOTES:**

1. Short field technique as specified in Section 4.
2. Prior to takeoff from fields above 5000 feet elevation, the mixture should be leaned to give maximum power in a full throttle, static runup.
3. Decrease distances 10% for each 9 knots headwind. For operation with tailwinds up to 10 knots, increase distances by 10% for each 2 knots.
4. Where distance value has been deleted, climb performance after lift-off is less than 150 fpm at takeoff speed.
5. For operation on a dry, grass runway, increase distances by 15% of the "ground roll" figure.

WEIGHT LBS	TAKEOFF SPEED KIAS		PRESS ALT FT	0°C		10°C		20°C		30°C		40°C	
	LIFT OFF	AT 50 FT		GRND ROLL FT	TOTAL FT TO CLEAR 50 FT OBS	GRND ROLL FT	TOTAL FT TO CLEAR 50 FT OBS	GRND ROLL FT	TOTAL FT TO CLEAR 50 FT OBS	GRND ROLL FT	TOTAL FT TO CLEAR 50 FT OBS	GRND ROLL FT	TOTAL FT TO CLEAR 50 FT OBS
3100	50	59	S.L.	720	1365	775	1465	835	1570	895	1680	955	1800
			1000	785	1490	845	1600	910	1720	975	1845	1045	1980
			2000	860	1635	925	1760	995	1890	1065	2035	1140	2185
			3000	940	1800	1010	1940	1085	2090	1165	2255	1250	2430
			4000	1025	1990	1105	2150	1190	2320	1275	2510	1370	2715
			5000	1125	2210	1215	2395	1305	2595	1400	2815	1505	3060
			6000	1235	2470	1330	2685	1435	2925	1540	3190	1655	3490
			7000	1360	2780	1465	3040	1580	3330	1700	3665	---	---
			8000	1500	3170	1615	3485	1740	3855	---	---	---	---

Figure 5-5. Takeoff Distance (Sheet 1 of 2)

**TAKEOFF DISTANCE**  
**2800 LBS AND 2500 LBS**  
**SHORT FIELD**

REFER TO SHEET 1 FOR APPROPRIATE CONDITIONS AND NOTES.

WEIGHT LBS	TAKEOFF SPEED KIAS		PRESS ALT FT	0°C		10°C		20°C		30°C		40°C	
	LIFT OFF	AT 50 FT		GRND ROLL FT	TOTAL FT TO CLEAR 50 FT OBS	GRND ROLL FT	TOTAL FT TO CLEAR 50 FT OBS	GRND ROLL FT	TOTAL FT TO CLEAR 50 FT OBS	GRND ROLL FT	TOTAL FT TO CLEAR 50 FT OBS	GRND ROLL FT	TOTAL FT TO CLEAR 50 FT OBS
2800	48	56	S.L.	575	1080	615	1155	660	1235	710	1320	760	1410
			1000	625	1175	670	1260	720	1350	770	1440	825	1540
			2000	680	1285	730	1375	785	1475	840	1580	900	1690
			3000	740	1405	800	1505	855	1615	920	1735	985	1860
			4000	810	1540	870	1655	935	1780	1005	1910	1075	2050
			5000	885	1695	955	1825	1025	1965	1100	2115	1180	2280
			6000	970	1875	1045	2025	1125	2185	1210	2355	1295	2545
			7000	1070	2085	1150	2255	1235	2440	1330	2640	1425	2865
8000	1175	2330	1265	2525	1360	2745	1465	2990	1570	3265			
2500	45	53	S.L.	445	845	475	900	510	960	545	1020	585	1085
			1000	485	915	520	975	555	1040	595	1110	635	1185
			2000	525	995	565	1060	605	1135	650	1210	695	1290
			3000	570	1080	615	1155	660	1235	705	1320	755	1410
			4000	625	1180	670	1265	720	1350	770	1445	825	1545
			5000	680	1290	735	1385	790	1480	845	1590	905	1700
			6000	745	1415	805	1520	860	1630	925	1750	990	1875
			7000	820	1560	890	1675	945	1800	1015	1935	1085	2080
8000	900	1725	965	1855	1040	2000	1115	2155	1195	2320			

Figure 5-5. Takeoff Distance (Sheet 2 of 2)

### MAXIMUM RATE OF CLIMB

**CONDITIONS:**

Flaps Up  
2400 RPM  
Full Throttle  
Mixture Full Rich  
Cowl Flaps Open

**NOTE:**

Mixture may be leaned above 5000 feet for smooth engine operation and increased power.

WEIGHT LBS	PRESS ALT FT	CLIMB SPEED KIAS	RATE OF CLIMB - FPM			
			-20°C	0°C	20°C	40°C
3100	S.L.	81	1010	925	845	765
	2000	80	885	805	730	650
	4000	78	760	685	610	540
	6000	77	640	570	495	425
	8000	76	520	450	380	310
	10,000	75	405	335	265	---
	12,000	73	285	220	155	---
	14,000	72	170	105	---	---

Figure 5-6. Maximum Rate of Climb

## TIME, FUEL, AND DISTANCE TO CLIMB

### MAXIMUM RATE OF CLIMB

**CONDITIONS:**

Flaps Up  
2400 RPM  
Full Throttle  
Mixture Full Rich  
Cowl Flaps Open  
Standard Temperature

**NOTES:**

1. Add 1.7 gallons of fuel for engine start, taxi and takeoff allowance.
2. Mixture may be leaned above 5000 feet for smooth engine operation and increased power.
3. Increase time, fuel and distance by 10% for each 10°C above standard temperature.
4. Distances shown are based on zero wind.

WEIGHT LBS	PRESSURE ALTITUDE FT	TEMP °C	CLIMB SPEED KIAS	RATE OF CLIMB FPM	FROM SEA LEVEL		
					TIME MIN	FUEL USED GALLONS	DISTANCE NM
3100	S.L.	15	81	865	0	0	0
	2000	11	80	760	2	0.8	3
	4000	7	78	660	5	1.7	7
	6000	3	77	555	9	2.7	12
	8000	- 1	76	455	13	3.9	18
	10,000	- 5	75	350	18	5.3	25
	12,000	- 9	73	250	25	7.1	36
	14,000	- 13	72	145	35	9.7	52

Figure 5-7. Time, Fuel, and Distance to Climb (Sheet 1 of 2)

## TIME, FUEL, AND DISTANCE TO CLIMB

### NORMAL CLIMB - 90 KIAS

**CONDITIONS:**

Flaps Up  
2400 RPM  
23 Inches Hg or Full Throttle  
Mixture Full Rich  
Cowl Flaps Open  
Standard Temperature

**NOTES:**

1. Add 1.7 gallons of fuel for engine start, taxi and takeoff allowance.
2. Mixture may be leaned above 5000 feet for smooth engine operation and increased power.
3. Increase time, fuel and distance by 10% for each 10°C above standard temperature.
4. Distances shown are based on zero wind.

WEIGHT LBS	PRESSURE ALTITUDE FT	TEMP °C	RATE OF CLIMB FPM	FROM SEA LEVEL		
				TIME MIN	FUEL USED GALLONS	DISTANCE NM
3100	S.L.	15	540	0	0	0
	2000	11	540	4	1.0	6
	4000	7	540	7	2.1	11
	6000	3	510	11	3.2	17
	8000	- 1	395	16	4.5	25
	10,000	- 5	285	22	6.1	35

Figure 5-7. Time, Fuel, and Distance to Climb (Sheet 2 of 2)



**CRUISE PERFORMANCE**  
**PRESSURE ALTITUDE 2000 FEET**

CONDITIONS:  
3100 Pounds  
Recommended Lean Mixture  
Cowl Flaps Closed

**NOTE**  
For best fuel economy at 65% power or less, operate at the leanest mixture that results in smooth engine operation or at peak EGT if an EGT indicator is installed.

RPM	MP	20°C BELOW STANDARD TEMP -9°C			STANDARD TEMPERATURE 11°C			20°C ABOVE STANDARD TEMP 31°C		
		% BHP	KTAS	GPH	% BHP	KTAS	GPH	% BHP	KTAS	GPH
2400	22	77	132	13.1	74	133	12.6	71	134	12.2
	21	72	129	12.3	69	130	11.8	67	131	11.4
	20	67	126	11.5	65	126	11.1	63	127	10.7
	19	62	122	10.7	60	122	10.3	58	122	10.0
2300	23	78	133	13.3	75	134	12.8	72	135	12.4
	22	73	130	12.5	70	131	12.0	68	131	11.6
	21	68	126	11.7	66	127	11.3	64	128	10.9
	20	64	123	10.9	62	123	10.5	60	123	10.2
2200	23	73	130	12.5	70	131	12.0	68	131	11.6
	22	69	127	11.7	66	127	11.3	64	128	10.9
	21	64	123	11.0	62	124	10.6	60	124	10.2
	20	60	119	10.2	58	120	9.9	56	120	9.6
2100	23	68	126	11.6	66	127	11.2	64	127	10.8
	22	64	123	10.9	62	123	10.5	60	124	10.2
	21	60	119	10.2	58	120	9.9	56	120	9.6
	20	56	115	9.6	54	115	9.3	52	115	9.0
	19	52	111	9.0	50	110	8.7	48	109	8.5
	18	47	106	8.4	46	105	8.1	44	103	7.9

Figure 5-8. Cruise Performance (Sheet 1 of 7)

**CRUISE PERFORMANCE**  
**PRESSURE ALTITUDE 4000 FEET**

CONDITIONS:  
3100 Pounds  
Recommended Lean Mixture  
Cowl Flaps Closed

**NOTE**  
For best fuel economy at 65% power or less, operate at the leanest mixture that results in smooth engine operation or at peak EGT if an EGT indicator is installed.

		20°C BELOW STANDARD TEMP -13°C			STANDARD TEMPERATURE 7°C			20°C ABOVE STANDARD TEMP 27°C		
RPM	MP	% BHP	KTAS	GPH	% BHP	KTAS	GPH	% BHP	KTAS	GPH
2400	22	---	---	---	76	137	13.0	73	138	12.5
	21	74	133	12.6	71	134	12.1	69	134	11.7
	20	69	129	11.8	66	130	11.3	64	130	11.0
	19	64	125	10.9	62	126	10.6	60	126	10.2
2300	23	---	---	---	76	138	13.1	74	139	12.6
	22	75	133	12.8	72	134	12.3	70	135	11.9
	21	70	130	12.0	68	131	11.5	65	131	11.2
	20	66	126	11.2	63	127	10.8	61	127	10.4
2200	23	75	133	12.8	72	134	12.3	70	135	11.9
	22	70	130	12.0	68	131	11.6	66	131	11.2
	21	66	127	11.3	64	127	10.9	61	127	10.5
	20	62	123	10.5	59	123	10.2	57	123	9.8
2100	23	70	130	11.9	67	131	11.5	65	131	11.1
	22	66	126	11.2	63	127	10.8	61	127	10.4
	21	62	123	10.5	59	123	10.1	57	123	9.8
	20	57	119	9.8	55	119	9.5	53	118	9.3
	19	53	114	9.2	51	114	8.9	50	113	8.7
	18	49	109	8.6	47	108	8.3	46	106	8.1
	17	45	103	8.0	43	101	7.8	42	100	7.6

Figure 5-8. Cruise Performance (Sheet 2 of 7)

## CRUISE PERFORMANCE

### PRESSURE ALTITUDE 6000 FEET

CONDITIONS:  
3100 Pounds  
Recommended Lean Mixture  
Cowl Flaps Closed

NOTE

For best fuel economy at 65% power or less, operate at the leanest mixture that results in smooth engine operation or at peak EGT if an EGT indicator is installed.

RPM	MP	20°C BELOW STANDARD TEMP -17°C			STANDARD TEMPERATURE 3°C			20°C ABOVE STANDARD TEMP 23°C		
		% BHP	KTAS	GPH	% BHP	KTAS	GPH	% BHP	KTAS	GPH
2400	22	---	---	---	77	141	13.3	75	142	12.8
	21	75	136	12.9	73	137	12.4	70	138	12.0
	20	71	133	12.1	68	133	11.6	66	134	11.2
	19	66	129	11.2	64	129	10.8	61	129	10.5
2300	22	77	137	13.1	74	138	12.6	71	139	12.2
	21	72	134	12.3	69	134	11.8	67	135	11.4
	20	67	130	11.5	65	130	11.1	63	131	10.7
	19	63	126	10.7	60	126	10.3	58	126	10.0
2200	22	72	134	12.3	69	135	11.9	67	135	11.5
	21	68	130	11.6	65	131	11.1	63	131	10.8
	20	63	126	10.8	61	127	10.4	59	127	10.1
	19	59	122	10.1	57	122	9.7	55	121	9.5
2100	22	67	130	11.5	65	131	11.1	63	131	10.7
	21	63	126	10.8	61	127	10.4	59	127	10.1
	20	59	122	10.1	57	122	9.8	55	122	9.5
	19	55	118	9.5	53	117	9.2	51	116	8.9
	18	51	113	8.8	49	111	8.6	47	110	8.3
	17	47	107	8.2	45	105	8.0	43	103	7.8

Figure 5-8. Cruise Performance (Sheet 3 of 7)

**CRUISE PERFORMANCE**  
**PRESSURE ALTITUDE 8000 FEET**

CONDITIONS:  
3100 Pounds  
Recommended Lean Mixture  
Cowl Flaps Closed

**NOTE**  
For best fuel economy at 65% power or less, operate at the leanest mixture that results in smooth engine operation or at peak EGT if an EGT indicator is installed.

RPM	MP	20°C BELOW STANDARD TEMP -21°C			STANDARD TEMPERATURE -1°C			20°C ABOVE STANDARD TEMP 19°C		
		% BHP	KTAS	GPH	% BHP	KTAS	GPH	% BHP	KTAS	GPH
2400	21	77	140	13.3	74	141	12.7	72	142	12.3
	20	72	136	12.4	70	137	11.9	67	138	11.5
	19	68	132	11.5	65	133	11.1	63	133	10.7
	18	63	128	10.7	60	128	10.3	58	128	10.0
2300	21	74	137	12.6	71	138	12.1	69	139	11.7
	20	69	134	11.8	66	134	11.3	64	134	11.0
	19	64	130	11.0	62	130	10.6	60	129	10.2
	18	60	125	10.2	58	125	9.9	56	124	9.6
2200	21	69	134	11.8	67	135	11.4	65	135	11.0
	20	65	130	11.1	63	130	10.7	60	130	10.3
	19	61	126	10.3	58	126	10.0	56	125	9.7
	18	56	121	9.7	54	120	9.3	52	119	9.1
2100	21	65	130	11.1	63	130	10.7	60	130	10.3
	20	61	126	10.4	59	126	10.0	57	125	9.7
	19	57	122	9.7	54	121	9.4	53	120	9.1
	18	52	116	9.1	50	115	8.8	49	113	8.5
	17	48	110	8.5	46	108	8.2	45	106	8.0

Figure 5-8. Cruise Performance (Sheet 4 of 7)

**CRUISE PERFORMANCE**  
**PRESSURE ALTITUDE 10,000 FEET**

CONDITIONS:  
3100 Pounds  
Recommended Lean Mixture  
Cowl Flaps Closed

**NOTE**  
For best fuel economy at 65% power or less, operate at the leanest mixture that results in smooth engine operation or at peak EGT if an EGT indicator is installed.

RPM	MP	20°C BELOW STANDARD TEMP -25°C			STANDARD TEMPERATURE -5°C			20°C ABOVE STANDARD TEMP 15°C		
		% BHP	KTAS	GPH	% BHP	KTAS	GPH	% BHP	KTAS	GPH
2400	20	74	140	12.7	71	141	12.2	69	141	11.8
	19	69	136	11.8	67	137	11.4	64	137	11.0
	18	65	132	11.0	62	132	10.6	60	131	10.2
	17	60	127	10.2	57	126	9.8	55	125	9.5
2300	20	71	137	12.1	68	138	11.6	66	138	11.2
	19	66	133	11.3	64	133	10.9	61	133	10.5
	18	61	129	10.5	59	128	10.1	57	128	9.8
	17	57	123	9.7	55	122	9.4	53	121	9.1
2200	20	67	134	11.4	64	134	11.0	62	134	10.6
	19	62	129	10.6	60	129	10.2	58	129	9.9
	18	58	125	9.9	56	124	9.6	54	123	9.3
	17	53	119	9.2	51	118	8.9	50	116	8.7
2100	20	63	130	10.7	60	130	10.3	58	129	9.9
	19	58	125	10.0	56	124	9.6	54	123	9.4
	18	54	120	9.3	52	119	9.0	50	117	8.8
	17	50	114	8.7	48	112	8.4	46	110	8.2
	16	46	107	8.1	44	104	7.8	42	102	7.6

Figure 5-8. Cruise Performance (Sheet 5 of 7)

**CRUISE PERFORMANCE**  
**PRESSURE ALTITUDE 12,000 FEET**

CONDITIONS:  
3100 Pounds  
Recommended Lean Mixture  
Cowl Flaps Closed

**NOTE**

For best fuel economy, operate at the leanest mixture that results in smooth engine operation or at peak EGT if an EGT indicator is installed.

RPM	MP	20°C BELOW STANDARD TEMP -29°C			STANDARD TEMPERATURE -9°C			20°C ABOVE STANDARD TEMP 11°C		
		% BHP	KTAS	GPH	% BHP	KTAS	GPH	% BHP	KTAS	GPH
2400	18	66	136	11.3	64	136	10.9	61	135	10.5
	17	61	130	10.5	59	130	10.1	57	129	9.8
	16	56	124	9.7	54	123	9.4	52	122	9.1
	15	51	117	9.0	50	116	8.7	48	114	8.4
2300	18	63	132	10.8	61	132	10.4	59	131	10.0
	17	58	127	10.0	56	126	9.7	54	125	9.4
	16	54	121	9.3	52	119	9.0	50	117	8.7
	15	49	113	8.6	47	112	8.3	45	109	8.1
2200	18	59	128	10.2	57	128	9.8	55	126	9.5
	17	55	123	9.5	53	121	9.2	51	119	8.9
	16	51	116	8.8	49	114	8.5	47	112	8.3
	15	46	108	8.2	44	106	7.9	43	103	7.7
2100	18	56	124	9.6	54	122	9.3	52	120	9.0
	17	51	117	8.9	49	115	8.7	48	113	8.4
	16	47	110	8.3	45	108	8.1	44	106	7.8

Figure 5-8. Cruise Performance (Sheet 6 of 7)

## CRUISE PERFORMANCE

### PRESSURE ALTITUDE 14,000 FEET

CONDITIONS:  
3100 Pounds  
Recommended Lean Mixture  
Cowl Flaps Closed

**NOTE**

For best fuel economy, operate at the leanest mixture that results in smooth engine operation or at peak EGT if an EGT indicator is installed.

		20°C BELOW STANDARD TEMP -33°C			STANDARD TEMPERATURE -13°C			20°C ABOVE STANDARD TEMP 7°C		
RPM	MP	% BHP	KTAS	GPH	% BHP	KTAS	GPH	% BHP	KTAS	GPH
2400	16	58	128	9.9	56	127	9.6	54	125	9.3
	15	53	121	9.2	51	119	8.9	49	117	8.6
	14	48	113	8.5	46	110	8.2	45	108	8.0
2300	16	55	124	9.5	53	123	9.2	51	121	8.9
	15	51	117	8.8	49	115	8.5	47	112	8.3
	14	46	109	8.1	44	106	7.9	42	103	7.7
2200	16	52	120	9.0	50	118	8.8	48	115	8.5
	15	48	112	8.4	46	110	8.1	44	107	7.9
2100	16	49	114	8.5	47	112	8.3	45	109	8.0

Figure 5-8. Cruise Performance (Sheet 7 of 7)

### RANGE PROFILE 45 MINUTES RESERVE 65 GALLONS USABLE FUEL

CONDITIONS:  
3100 Pounds  
Recommended Lean Mixture for Cruise  
Standard Temperature  
Zero Wind

NOTE:  
This chart allows for the fuel used for engine start, taxi, takeoff and climb, and the distance during a normal climb up to 10,000 feet and maximum climb above 10,000 feet.

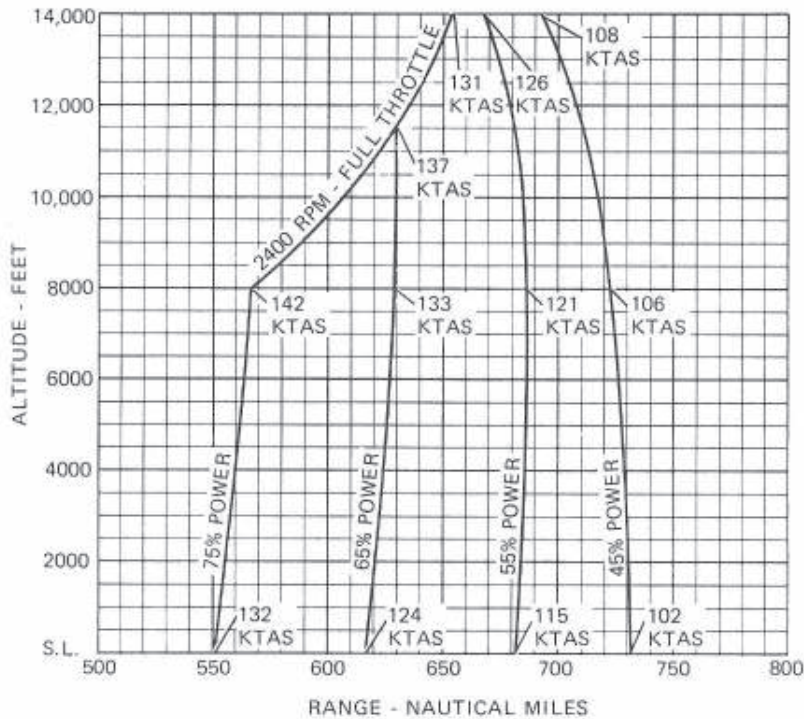

Figure 5-9. Range Profile (Sheet 1 of 2)



### RANGE PROFILE 45 MINUTES RESERVE 88 GALLONS USABLE FUEL

CONDITIONS:  
3100 Pounds  
Recommended Lean Mixture for Cruise  
Standard Temperature  
Zero Wind

NOTE:  
This chart allows for the fuel used for engine start, taxi, takeoff and climb, and the distance during a normal climb up to 10,000 feet and maximum climb above 10,000 feet.

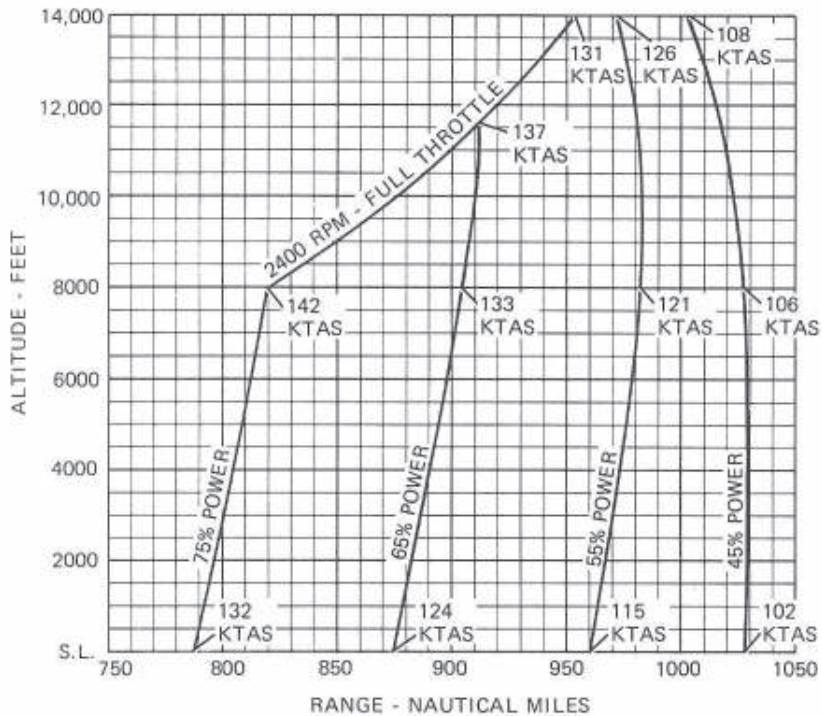

Figure 5-9. Range Profile (Sheet 2 of 2)

### ENDURANCE PROFILE 45 MINUTES RESERVE 65 GALLONS USABLE FUEL

CONDITIONS:  
3100 Pounds  
Recommended Lean Mixture for Cruise  
Standard Temperature

NOTE:  
This chart allows for the fuel used for engine start, taxi, takeoff and climb, and the time during a normal climb up to 10,000 feet and maximum climb above 10,000 feet.

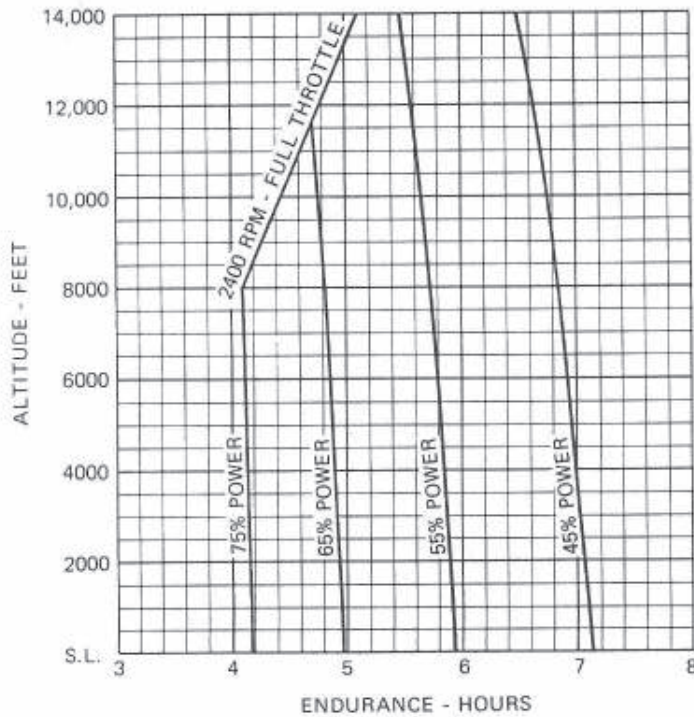

Figure 5-10. Endurance Profile (Sheet 1 of 2)

### ENDURANCE PROFILE 45 MINUTES RESERVE 88 GALLONS USABLE FUEL

CONDITIONS:  
3100 Pounds  
Recommended Lean Mixture for Cruise  
Standard Temperature

NOTE:  
This chart allows for the fuel used for engine start, taxi, takeoff and climb, and the time during a normal climb up to 10,000 feet and maximum climb above 10,000 feet.

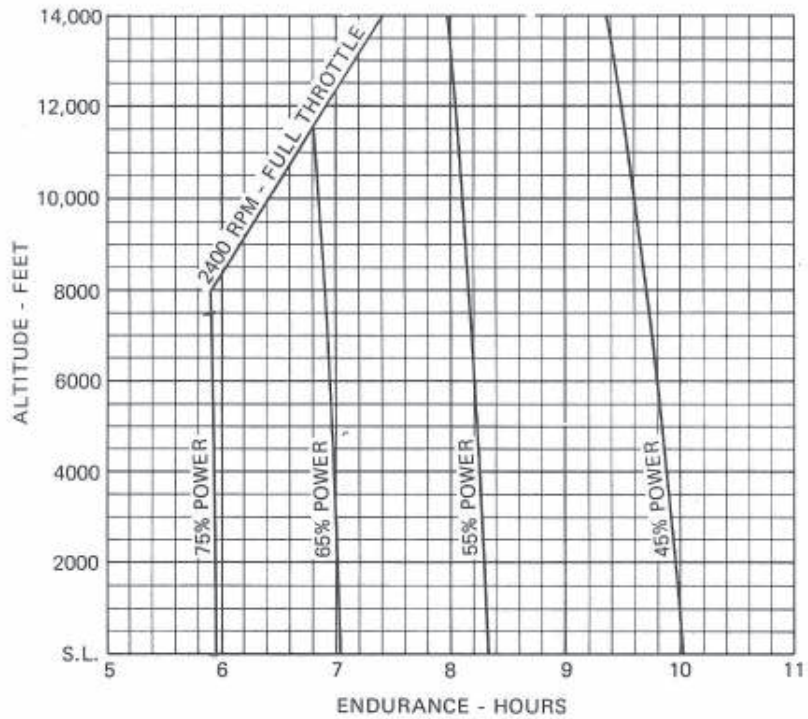

Figure 5-10. Endurance Profile (Sheet 2 of 2)

## LANDING DISTANCE

### SHORT FIELD

**CONDITIONS:**

Flaps FULL  
Power Off  
Maximum Braking  
Paved, Level, Dry Runway  
Zero Wind

**NOTES:**

1. Short field technique as specified in Section 4.
2. Decrease distances 10% for each 9 knots headwind. For operation with tailwinds up to 10 knots, increase distances by 10% for each 2 knots.
3. For operation on a dry, grass runway, increase distances by 40% of the "ground roll" figure.
4. If a landing with flaps up is necessary, increase the approach speed by 10 KIAS and allow for 40% longer distances.

WEIGHT LBS	SPEED AT 50 FT KIAS	PRESS ALT FT	0°C		10°C		20°C		30°C		40°C	
			GRND ROLL FT	TOTAL FT TO CLEAR 50 FT OBS	GRND ROLL FT	TOTAL FT TO CLEAR 50 FT OBS	GRND ROLL FT	TOTAL FT TO CLEAR 50 FT OBS	GRND ROLL FT	TOTAL FT TO CLEAR 50 FT OBS	GRND ROLL FT	TOTAL FT TO CLEAR 50 FT OBS
2950	61	S.L.	560	1300	580	1335	600	1365	620	1400	640	1435
		1000	580	1335	600	1365	620	1400	645	1440	665	1475
		2000	600	1370	625	1405	645	1440	670	1480	690	1515
		3000	625	1410	645	1445	670	1485	695	1525	715	1560
		4000	650	1450	670	1485	695	1525	720	1565	740	1600
		5000	670	1485	695	1525	720	1565	745	1610	770	1650
		6000	700	1530	725	1575	750	1615	775	1660	800	1700
		7000	725	1575	750	1615	780	1665	805	1710	830	1750
		8000	755	1625	780	1665	810	1715	835	1760	865	1805

Figure 5-11. Landing Distance

CESSNA  
MODEL 182R

SECTION 6  
WEIGHT & BALANCE/  
EQUIPMENT LIST

# SECTION 6 WEIGHT & BALANCE/ EQUIPMENT LIST

## TABLE OF CONTENTS

	Page
Introduction . . . . .	6-3
Airplane Weighing Procedures . . . . .	6-3
Weight And Balance . . . . .	6-6
Baggage and Cargo Tie-Down . . . . .	6-6
Equipment List . . . . .	6-15

## INTRODUCTION

This section describes the procedure for establishing the basic empty weight and moment of the airplane. Sample forms are provided for reference. Procedures for calculating the weight and moment for various operations are also provided. A comprehensive list of all Cessna equipment available for this airplane is included at the back of this section.

It should be noted that specific information regarding the weight, arm, moment and installed equipment for this airplane as delivered from the factory can only be found in the plastic envelope carried in the back of this handbook.

It is the responsibility of the pilot to ensure that the airplane is loaded properly.

## AIRPLANE WEIGHING PROCEDURES

1. Preparation:
  - a. Inflate tires to recommended operating pressures.
  - b. Remove the fuel tank sump quick-drain fittings and fuel selector valve drain plug to drain all fuel.
  - c. Service engine oil as required to obtain a normal full indication (12 quarts on dipstick).
  - d. Move sliding seats to the most forward position.
  - e. Raise flaps to the fully retracted position.
  - f. Place all control surfaces in neutral position.
2. Leveling:
  - a. Place scales under each wheel (minimum scale capacity, 1000 pounds).
  - b. Deflate nose tire and/or lower or raise the nose strut to properly center bubble on level (see figure 6-1).
3. Weighing:
  - a. With the airplane level and brakes released, record the weight shown on each scale. Deduct the tare, if any, from each reading.
4. Measuring:
  - a. Obtain measurement A by measuring horizontally (along the airplane center line) from a line stretched between the main wheel centers to a plumb bob dropped from the firewall.
  - b. Obtain measurement B by measuring horizontally and parallel to the airplane center line, from center of nose wheel axle, left side, to a plumb bob dropped from the line between the main wheel centers. Repeat on right side and average the measurements.
5. Using weights from item 3 and measurements from item 4, the airplane weight and C.G. can be determined.
6. Basic Empty Weight may be determined by completing figure 6-1.

SECTION 6  
WEIGHT & BALANCE/  
EQUIPMENT LIST

CESSNA  
MODEL 182R

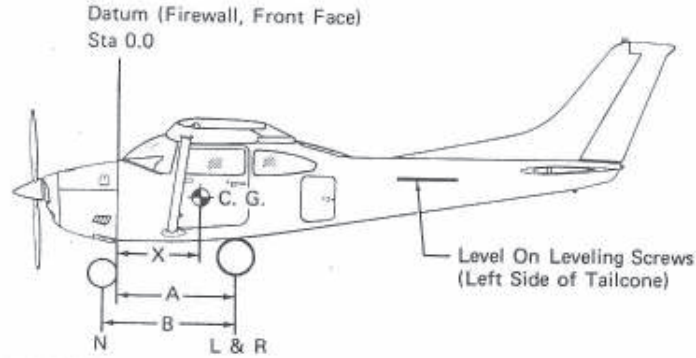

Scale Position	Scale Reading	Tare	Symbol	Net Weight
Left Wheel			L	
Right Wheel			R	
Nose Wheel			N	
Sum of Net Weights (As Weighed)			W	

$$X = \text{ARM} = \frac{(A) - (N) \times (B)}{W}; X = ( \quad ) - \frac{( \quad ) \times ( \quad )}{( \quad )} = ( \quad ) \text{ IN.}$$

Item	Weight (Lbs.)	X C.G. Arm (In.)	Moment/1000 (Lbs.-In.)
Airplane Weight (From Item 5, page 6-3)			
Add: Unusable Fuel (4 Gal at 6 Lbs/Gal)	24	48.0	1.2
Equipment Changes			
Airplane Basic Empty Weight			

Figure 6-1. Sample Airplane Weighing

**SAMPLE WEIGHT AND BALANCE RECORD**

(Continuous History of Changes in Structure or Equipment Affecting Weight and Balance)

AIRPLANE MODEL			SERIAL NUMBER	PAGE NUMBER							
DATE	ITEM NO.		WEIGHT CHANGE				RUNNING BASIC EMPTY WEIGHT				
	In	Out	ADDED (+)		REMOVED (-)		Wt. (lb.)	Moment /1000			
			Arm (in.)	Moment /1000	Wt. (lb.)	Arm (in.)			Moment /1000		
			As Delivered								

Figure 6-2. Sample Weight and Balance Record



## WEIGHT AND BALANCE

The following information will enable you to operate your Cessna within the prescribed weight and center of gravity limitations. To figure weight and balance, use the Sample Problem, Loading Graph, and Center of Gravity Moment Envelope as follows:

Take the basic empty weight and moment from appropriate weight and balance records carried in your airplane, and enter them in the column titled YOUR AIRPLANE on the Sample Loading Problem.

### NOTE

In addition to the basic empty weight and moment noted on these records, the C.G. arm (fuselage station) is also shown, but need not be used on the Sample Loading Problem. The moment which is shown must be divided by 1000 and this value used as the moment/1000 on the loading problem.

Use the Loading Graph to determine the moment/1000 for each additional item to be carried; then list these on the loading problem.

### NOTE

Loading Graph information for the pilot, passengers, and baggage/cargo is based on seats positioned for average occupants and baggage/cargo items loaded in the center of these areas as shown on the Loading Arrangements diagram. For loadings which may differ from these, the Sample Loading Problem lists fuselage stations for these items to indicate their forward and aft C.G. range limitation (seat travel and baggage/cargo area limitation). Additional moment calculations, based on the actual weight and C.G. arm (fuselage station) of the item being loaded, must be made if the position of the load is different from that shown on the Loading Graph.

Total the weights and moments/1000 and plot these values on the Center of Gravity Moment Envelope to determine whether the point falls within the envelope, and if the loading is acceptable.

## BAGGAGE AND CARGO TIE-DOWN

A nylon baggage net having six tie-down straps is provided as standard equipment to secure baggage in the area aft of the rear seat (baggage areas A, B and C). Eight eyebolts serve as attaching points for the

net. Two eyebolts are mounted on the cabin floor near each sidewall just forward of the baggage door approximately at station 92; two eyebolts mount on the floor slightly inboard of each sidewall just aft of the baggage door approximately at station 109; two eyebolts are mounted near the upper forward surface of the shelf area approximately at station 122; and two eyebolts secure at the bottom of the forward portion of the shelf area at station 124. If a child's seat is installed, only the eyebolts at station 109 and the remaining aft eyebolts will be needed for securing the net in the area remaining behind the seat. A placard on the baggage door defines the weight limitations in the baggage areas.

When baggage area A is utilized for baggage only, the four forward eyebolts should be used. When only baggage area B is used, the eyebolts just aft of the baggage door and the eyebolts above or below the shelf area may be used. When only baggage area C is utilized, the eyebolts above and below the shelf area should be used. When the cabin floor (baggage areas A and B) is utilized for baggage, the four forward eyebolts and the eyebolts mounted above or below the shelf area should be used. When there is baggage in areas B and C, the eyebolts just aft of the baggage door and the eyebolts above and below the shelf area should be used. When baggage is contained in all three areas, the two forward eyebolts on the cabin floor, the eyebolts just aft of the baggage door or the eyebolts at the bottom of the forward portion of the shelf area and the eyebolts near the upper forward surface of the shelf area should be used.

Cargo tie-down blocks and latch assemblies are available from any Cessna Dealer if it is desired to remove the rear seat (and child's seat, if installed) and utilize the rear cabin area to haul cargo. Two tie-down blocks may be clamped to the aft end of the two outboard front seat rails and are locked in place by a bolt which must be tightened to a minimum of fifty inch pounds. Seven tie-down latches may be bolted to standard attach points in the cabin floor, including three rear seat mounting points. The seven attach points are located as follows: two are located slightly inboard and just aft of the rear doorposts approximately at station 69; two utilize the aft outboard mounting points of the rear seat; one utilizes the rearmost mounting point of the aft center attach point for the rear seat approximately at station 84 (a second mounting point is located just forward of this point but is not used); and two are located just forward of the center baggage net tie-down eyebolts approximately at station 108. The maximum allowable floor loading of the rear cabin area is 200 pounds/square foot; however, when items with small or sharp support areas are carried, the installation of a 1/4" plywood floor is recommended to protect the airplane structure. The maximum rated load weight capacity for each of the seven tie-downs is 140 pounds and for the two seat rail tie-downs is 100 pounds. Rope, strap, or cable used for tie-down should be rated at a minimum of ten times the load weight capacity of the tie-down fittings used. Weight and balance calculations for cargo in the area of the rear seat

and baggage area can be figured on the Loading Graph using the lines labeled 2nd Row Passengers or Cargo and/or Baggage or Passengers on Child's Seat.

### LOADING ARRANGEMENTS

\*Pilot or passenger center of gravity on adjustable seats positioned for average occupant.  
 Numbers in parentheses indicate forward and aft limits of occupant center of gravity range.

\*\*Arms measured to the center of the areas shown.

- NOTES: 1. The usable fuel C.G. arm is located at station 46.5.  
 2. The aft baggage wall (approximate station 134) can be used as a convenient interior reference point for determining the location of baggage area fuselage stations.

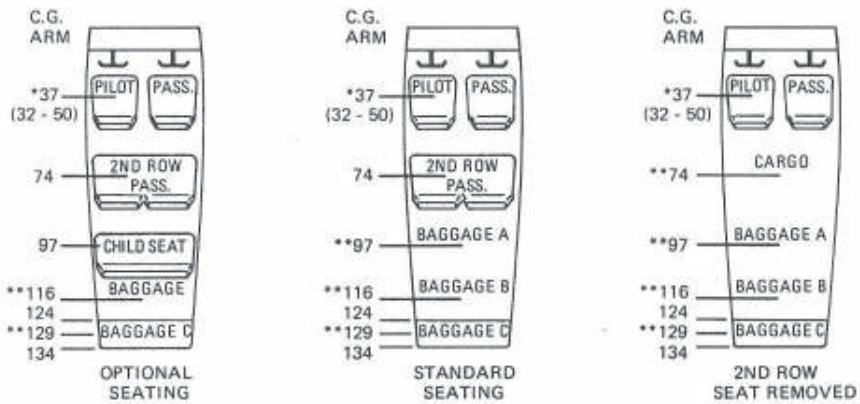

Figure 6-3. Loading Arrangements

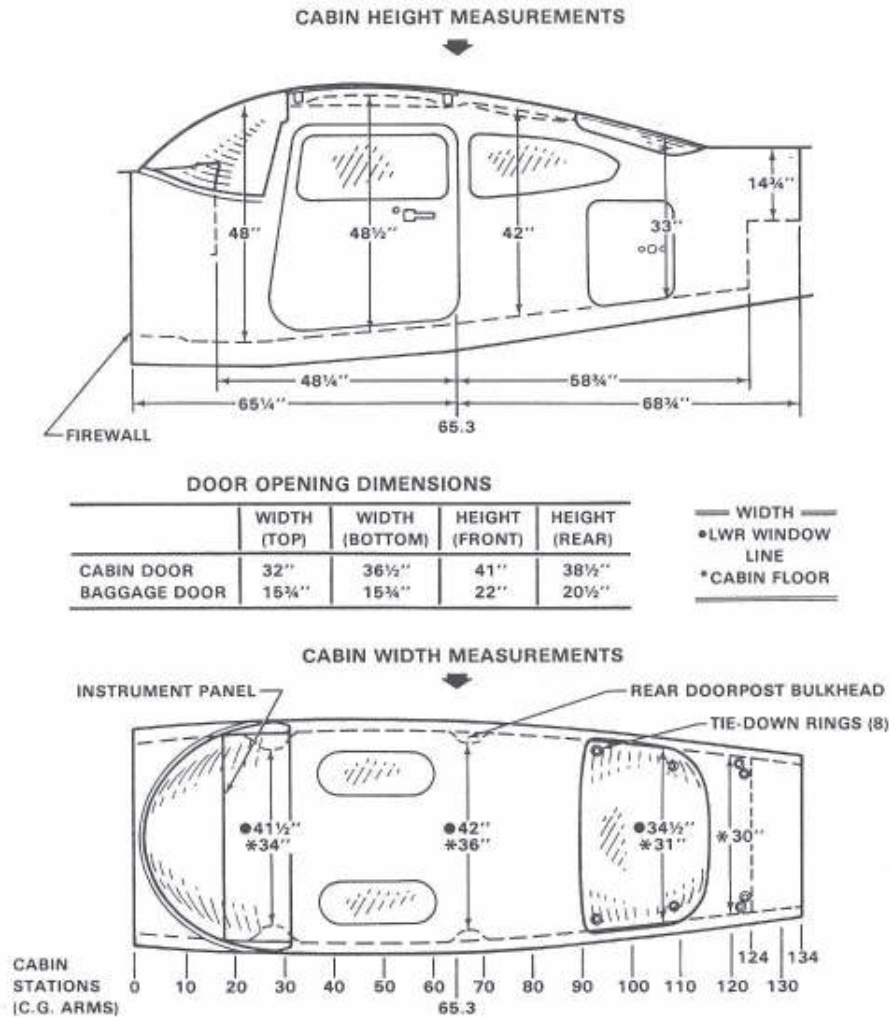

Figure 6-4. Internal Cabin Dimensions

SECTION 6  
WEIGHT & BALANCE/  
EQUIPMENT LIST

CESSNA  
MODEL 182R

SAMPLE LOADING PROBLEM	SAMPLE AIRPLANE		YOUR AIRPLANE	
	Weight (lbs.)	Moment (lb.-ins. /1000)	Weight (lbs.)	Moment (lb.-ins. /1000)
1. Basic Empty Weight (Use the data pertaining to your airplane as it is presently equipped. Includes unusable fuel and full oil) . . . . .	1800	63.3		
2. Usable Fuel (At 6 Lbs./Gal) Standard Tanks (88 Gal. Maximum) . . . . .	528	24.6		
Reduced Fuel (65 Gal.) . . . . .				
3. Pilot and Front Passenger (Station 32 to 50) . . . . .	340	12.6		
4. Second Row Passengers . . . . .	340	25.2		
Cargo Replacing Second Row Seats (Sta. 65 to 82) . . . . .				
5. *Baggage (Area "A") or Passenger on Child's Seat (Sta. 82 to 109) 120 Lbs. Maximum . . . . .	90	8.7		
6. *Baggage (Area "B") (Sta. 109 to 124) 80 Lbs. Maximum . . . . .	12	1.4		
7. *Baggage (Area "C") (Sta. 124 to 134) 80 Lbs. Maximum . . . . .				
8. RAMP WEIGHT AND MOMENT	3110	135.8		
9. Fuel allowance for engine start, taxi and runup .	- 10	-.5		
10. TAKEOFF WEIGHT AND MOMENT (Subtract step 9 from step 8)	3100	135.3		
<p>11. Locate this point (3100 at 135.3) on the Center of Gravity Moment Envelope, and since this point falls within the envelope, the loading is acceptable; provided that flight time is allowed for fuel burn-off to a maximum of 2950 pounds before landing.</p> <p>*The maximum allowable combined weight capacity for baggage in areas A, B, and C is 200 pounds.</p> <p>*The maximum allowable combined weight capacity for baggage in areas B and C is 80 pounds.</p>				

Figure 6-5. Sample Loading Problem (Sheet 1 of 2)

YOUR AIRPLANE		3/19/90 YOUR AIRPLANE		YOUR AIRPLANE		YOUR AIRPLANE	
Weight (lbs.)	Moment (lb.-ins. /1000)	Weight (lbs.)	Moment (lb.-ins. /1000)	Weight (lbs.)	Moment (lb.-ins. /1000)	Weight (lbs.)	Moment (lb.-ins. /1000)
		1914.62					
<p>When several loading configurations are representative of your operations, it may be useful to fill out one or more of the above columns so that specific loadings are available at a glance.</p>							

Figure 6-5. Sample Loading Problem (Sheet 2 of 2)

SECTION 6  
WEIGHT & BALANCE/  
EQUIPMENT LIST

CESSNA  
MODEL 182R

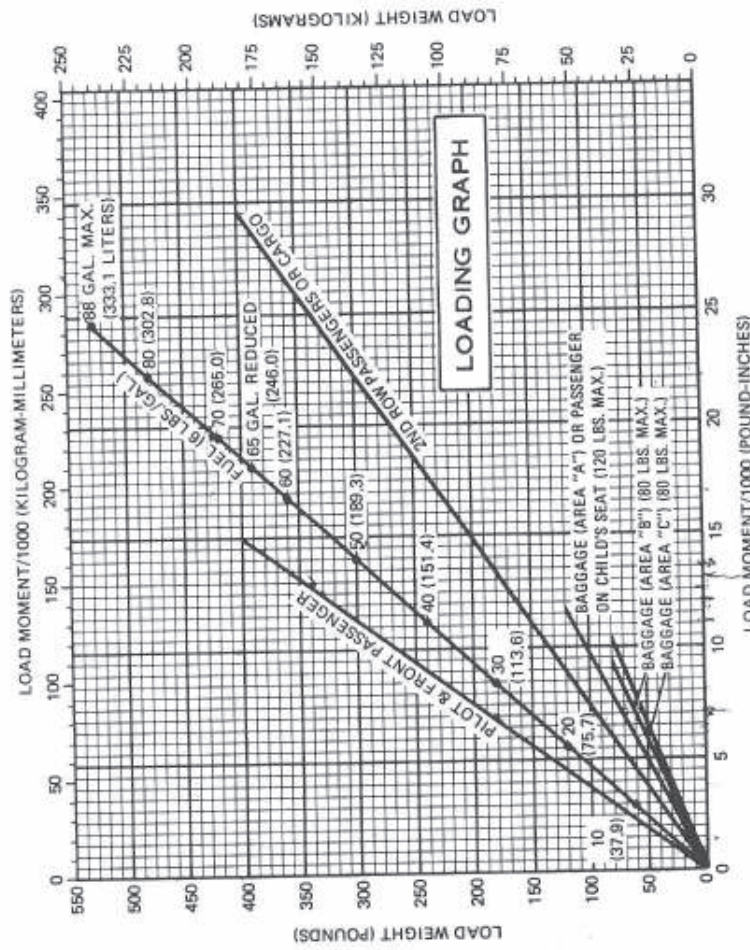

NOTE: 1. Line representing adjustable seats shows pilot and front seat passenger center of gravity on adjustable seats positioned for an average occupant. Refer to the Loading Arrangements diagram for forward and aft limits of occupant C.G. range.

Figure 6-6. Loading Graph

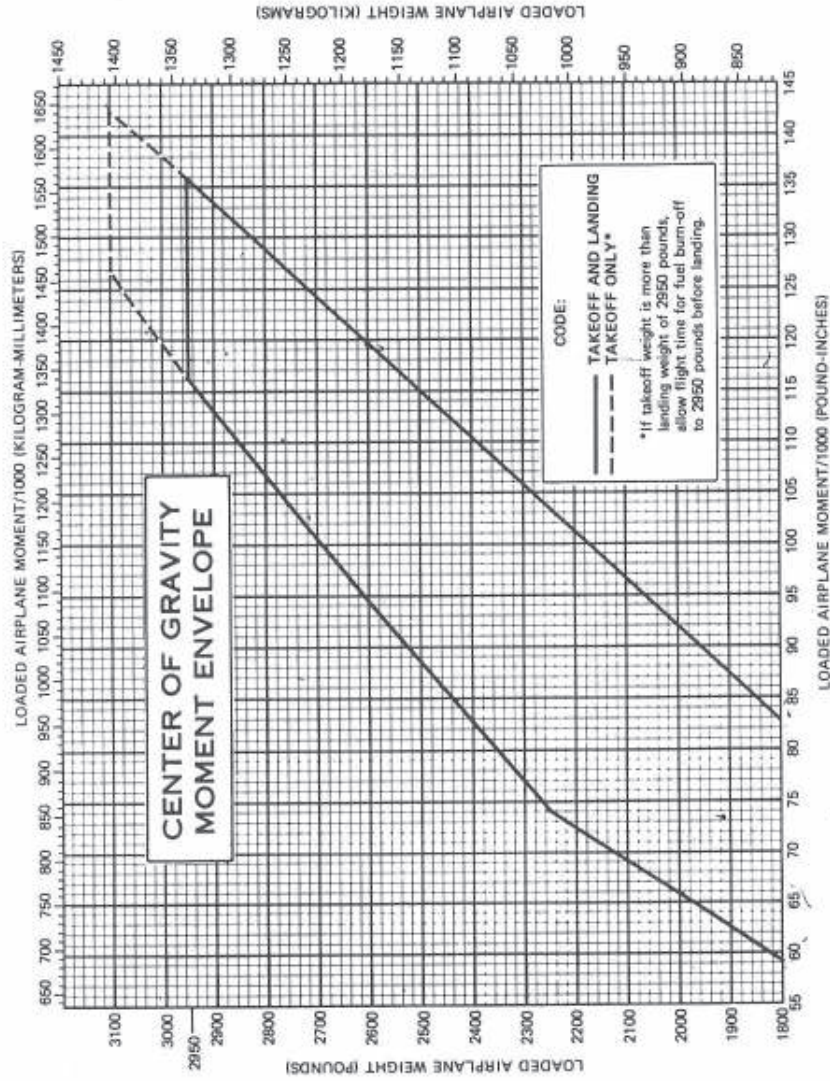

Figure 6-7. Center of Gravity Moment Envelope



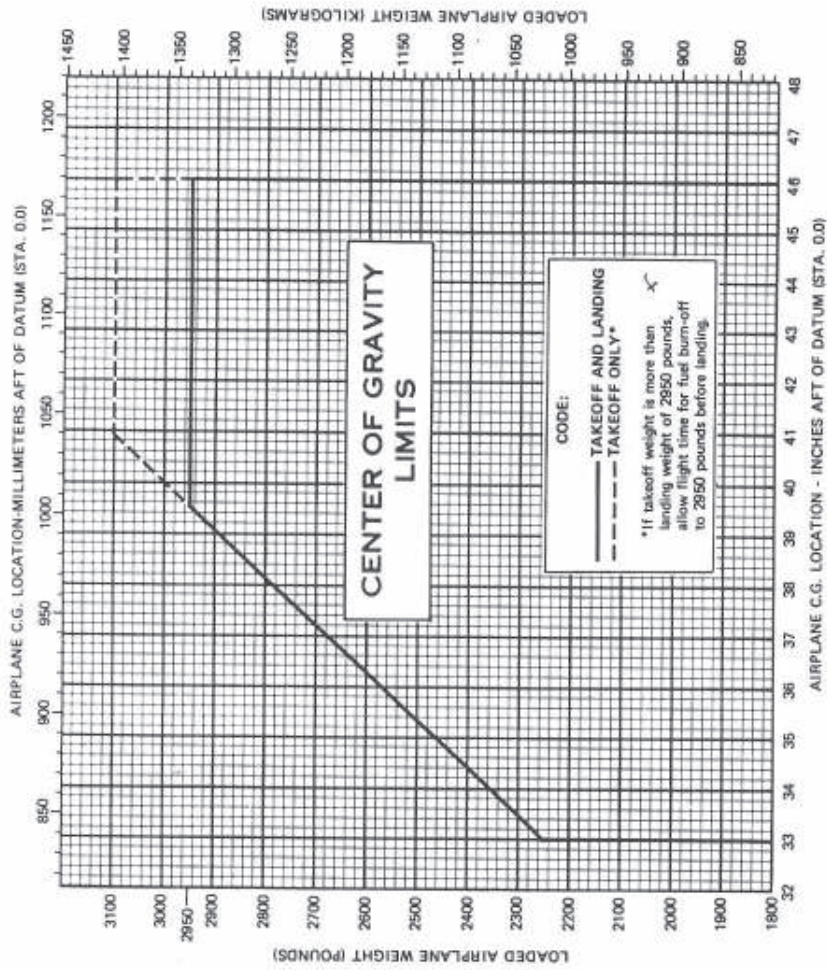

Figure 6-8. Center of Gravity Limits

## EQUIPMENT LIST

The following equipment list is a comprehensive list of all Cessna equipment available for this airplane. A separate equipment list of items installed in your specific airplane is provided in your aircraft file. The following list and the specific list for your airplane have a similar order of listing.

This equipment list provides the following information:

An **item number** gives the identification number for the item. Each number is prefixed with a letter which identifies the **descriptive** grouping (example: A. Powerplant & Accessories) under which it is listed. Suffix letters identify the equipment as a required item, a standard item or an optional item. Suffix letters are as follows:

- R = required items of equipment for FAA certification
- S = standard equipment items
- O = optional equipment items replacing required or standard items
- A = optional equipment items which are in addition to required or standard items

A **reference drawing** column provides the drawing number for the item.

### NOTE

If additional equipment is to be installed, it must be done in accordance with the reference drawing, accessory kit instructions, or a separate FAA approval.

Columns showing **weight (in pounds)** and **arm (in inches)** provide the weight and center of gravity location for the equipment.

### NOTE

Unless otherwise indicated, true values (not net change values) for the weight and arm are shown. Positive arms are distances aft of the airplane datum; negative arms are distances forward of the datum.

### NOTE

Asterisks (\*) after the item weight and arm indicate complete assembly installations. Some major components of the assembly are listed on the lines immediately following. The summation of these major components does not necessarily equal the complete assembly installation.

SECTION 6  
WEIGHT & BALANCE/  
EQUIPMENT LIST

CESSNA  
MODEL 182R

ITEM NO	EQUIPMENT LIST DESCRIPTION	REF DRAWING	WT LBS	ARM INS
A01-R	A. POWERPLANT & ACCESSORIES ENGINE, CONTINENTAL O-470-U SPEC 11 -MAGNETOS WITH IMPULSE COUPLING (2) -CARBURETOR, MARVEL SCHEBLER -OIL COOLER-HARRISON -SPARK PLUGS, 18MM X 3/4 20-3A (12) -STARTER, 24 VOLT PRESTOLITE -OIL FILTER	0750201-19 SLICK-6214 MA-4-5 TCM 627392 RHB-32E TCM 637487	446.3* 10.3 5.8 4.6 2.8 17.8 1.1	-16.4* -12.0 -9.6 -31.5 -19.0 -4.5 -4.1
A05-R	FILTER, CARBURETOR AIR	0750038-4	1.0	-33.0
A09-R	ALTERNATOR, 28 VOLT, 60 AMP	C611503-0102	10.8	-5.5
A17-0	OIL COOLER, NON-CONGEAL MODINE 1E-1605-D REPLACES OIL COOLER ON ITEM A01-R AND CHANGES ENGINE DESIGNATION TO O-470-U SPEC. 12	0750201-20	1.5	-31.5
A33-R	PROPELLER, MCCAULEY C2A34C204/90DCB-8	C161009-0106	50.8	-41.6
A37-R	GOVERNOR, PROPELLER (MCCAULEY C290-D3/T14)	C161031-0107	2.5	-32.5
A41-R	SPINNER INSTALLATION, PROPELLER -SPINNER DOME -FORWARD SPINNER SUPPORT -AFT SPINNER BULKHEAD	0752638-5 0752637-11 1250412-3 0752637-1	3.0* 1.7 0.2 1.1	-42.0* -44.2 -46.5 -37.8
A61-S	VACUUM SYSTEM, ENGINE DRIVEN -VACUUM PUMP	0706003-1 C431003-0102	2.2* 1.8	-2.9* -3.1
A61-0	VACUUM SYSTEM, STANDBY	2201135	8.0	1.7
A70-0	PRIMING SYSTEM, 6-CYLINDER	0750125	1.0	-15.0
A73-0	OIL QUICK DRAIN VALVE INSTL. (NET CHG)	1701015-4	0.0	0.0

ITEM NO	EQUIPMENT LIST DESCRIPTION	REF DRAWING	WT LBS	ARM INS
B01-R	B. LANDING GEAR & ACCESSORIES WHEEL, BRAKE & TIRE ASSY, 6.00X6 MAIN (2) -WHEEL MCCAULEY (EACH) -BRAKE ASSY, MCCAULEY (LEFT) -BRAKE ASSY, MCCAULEY (RIGHT) -TIRE, 6 PLY RATED BLACKWALL (EACH) -TUBE	C163019B0206 C163006-0103 C163032-0205 C163032-0206 C262003-0204 C262023-0102	41.2* 8.4 3.0 7.9 1.3	58.4* 58.9 55.5 55.5 58.9
B04-R-1	WHEEL & TIRE ASSY, 5.00X5 NOSE -WHEEL ASSY, CLEVELAND 40-77 -TIRE, 6-PLY RATED BLACKWALL -TUBE	1241156-104 1241156-12 C262003-0202 C262023-0101	8.8* 2.8 4.6 1.4	-7.1* -7.1 -7.1 -7.1
B04-R-2	WHEEL & TIRE ASSY, 5.00X5 NOSE -WHEEL ASSEMBLY, MCCAULEY -TIRE, 6 PLY RATED BLACKWALL -TUBE	C163018B0103 C163005-0201 C262003-0202 C262023-0101	9.8* 3.8 4.6 1.4	-7.1* -7.1 -7.1 -7.1
B10-A	FAIRING INSTALLATION, WHEEL (SET OF 3) -NOSE WHEEL FAIRING (EACH) -MAIN WHEEL FAIRING (EACH) -BRAKE DISC FAIRING (EACH)	0741638 0543088-3 0541229-3,-4 0741641	18.4* 3.9 5.7 0.6	45.9* -6.0 60.2 58.0
B16-R	AXLE, STANDARD DUTY MAIN GEAR (SET OF 2)	0541124-1	2.6	58.9
B16-O	AXLE, HEAVY DUTY MAIN GEAR (SET OF 2)	1441003-1	4.5	58.9
C01-R	C. ELECTRICAL SYSTEMS BATTERY, 24 VOLT, STANDARD DUTY	C614002-0101	23.2	130.0
C01-O	BATTERY, 24 VOLT, HEAVY DUTY	C614002-0102	25.2	130.0
C04-R	ALTERNATOR CONTROL UNIT, 28 VOLT W/HIGH VOLTAGE PROTECTION & LOW VOLTAGE SENSING	C611005-0101	0.4	-0.3
C07-A	GROUND SERVICE PLUG RECEPTACLE	2270017-2	3.1	138.9
C10-A	ELECTRIC ELEVATOR TRIM INSTL -ACTUATOR AND MOUNT	2270028-3 44430-3257	4.5* 2.3	184.5* 220.2

SECTION 6  
WEIGHT & BALANCE/  
EQUIPMENT LIST

CESSNA  
MODEL 182R

ITEM NO	EQUIPMENT LIST DESCRIPTION	REF DRAWING	WT LBS	ARM INS
C19-0	HEATING SYSTEM, PITOT & STALL WARNING SWITCH	0770724-2	0.5	26.5
C22-A	LIGHTS, INSTRUMENT POST	2201003-2	0.5	17.5
C23-A	PANEL LIGHTS, ELECTRO-LUMINESCENT INSTL.	0770419	0.9	12.0
C25-A	MAP LIGHT, CONTROL WHEEL MOUNTED (CHANGES CONTROL WHEEL, E89-0, FROM 1260243-2 TO 1260243-9)	1260243-9	0.1	27.0
C31-A	LIGHTS, COURTESY (NET CHANGE)	0700615-11	0.5	61.7
C40-A	DETECTORS, NAVIGATION LIGHT (SET OF 2)	0701013-1,-2	0.0	0.0
C43-A	OMNI FLASHING BEACON LIGHT -LIGHT ASSY (IN FIN TIP) -FLASHER ASSY (IN AFT TAIL CONE) -LOADING RESISTOR	0701042-2 C621001-0102 C594502-0102 OR 95-6	1.8* 0.7 0.4 0.2	208.6* 253.0 253.0 212.0
C46-A	STROBE LIGHTS, WHITE (EACH WING TIP (2) -POWER SUPPLY (AEROFILASH 152-0009) -LIGHT ASSY. (AEROFILASH 73-145) (2)	2201008-1 C622008-0102 C622006-0107	2.6* 2.3 0.3	46.6* 46.7 42.0
C49-S	LIGHT INSTL, COWL MOUNTED LANDING & TAXI -LIGHT BULBS (2)	0770417 4591	1.6* 1.0	-25.3* -32.5
D01-R	D. INSTRUMENTS INDICATOR, AIRSPEED	C661064-0234	0.6	16.0
D01-0	INDICATOR, TRUE AIRSPEED (NET CHANGE)	1201108-21	0.2	16.5
D04-A	STATIC ALTERNATE AIR SOURCE	0701028-1	0.3	14.4
D07-R	ALTIMETER, SENSITIVE	C661071-0101	0.8	15.3
D07-0-1	ALTIMETER, SENSITIVE (FEET & MILLIBARS)	C661071-0102	0.8	15.3
D07-0-2	ALTIMETER, SENSITIVE (20 FT. MARKINGS)	C661025-0102	0.7	15.3
D10-A	ALTIMETER INSTALLATION (2ND UNIT)	1213681	0.8	16.0

ITEM NO	EQUIPMENT LIST DESCRIPTION	REF DRAWING	WT LBS	ARM INS
D16-A-1	ENCODING ALTIMETER (REQUIRES RELOCATING STANDARD TYPE ALTIMETER)	1213732	3.0	14.0
D16-A-2	ENCODING ALTIMETER, FEET AND MILLIBARS (REQUIRES RELOCATING STANDARD ALTIMETER)	1213732	3.0	14.0
D16-A-3	ALTITUDE ENCODER, BLIND (INSTRUMENT PANEL INSTALLATION NOT REQUIRED) -ENCODER -MISC. HARDWARE	0701099 C744001-0101	1.7* 1.3 0.4	13.6* 13.6 13.6
D22-A	GAGE, CARBURETOR AIR TEMPERATURE	0750610-2	1.2	16.0
D25-S	CLOCK, ELECTRIC, DIAL READ	C664508-0102	0.3	16.6
D25-0	CLOCK, ELECTRIC, DIGITAL (NET CHANGE) -CLOCK/CHRONOMETER	0770776-8 C664511-0102	0.3* 0.6	16.6* 16.3
D28-R	COMPASS, MAGNETIC & MOUNT	1213679-3	1.1	20.5
D34-R	INSTRUMENT CLUSTER, ENGINE & FUEL	C669545-0110	1.3	16.5
D49-A	INDICATOR INSTL. ECONOMY MIXTURE (EGT) -EGT INDICATOR -THERMOCOUPLE PROBE -THERMOCOUPLE LEAD WIRE (IC)	0750609-2 C668501-0211 C668501-0204 C668501-0206	0.7* 0.4 0.1 0.1	8.2* 17.1 -20.5 -0.3
D64-S	GYRO SYSTEM INSTL., NO AUTOPILOT -DIRECTIONAL INDICATOR -ATTITUDE INDICATOR -HOSES, FITTINGS, SCREWS, CLAMPS ETC. (ALTERNATE C661075 & C661076 GYRO'S MAY BE USED)	0706008-1 C661075-0101 C661076-0101	5.9* 2.4 1.8 1.7	12.4* 12.5 14.1 9.0
D64-0	GYRO SYSTEM INSTL., SPERRY 300A AUTOPILOT -DIRECTIONAL INDICATOR (AUTOPILOT) -ATTITUDE INDICATOR (AUTOPILOT) (ALTERNATE C661076 ATTITUDE GYRO'S MAY BE USED)	0706008-2 40740-0114 C661076-0101	6.1* 2.6 1.8	12.4* 13.5 14.1
D67-A	HOURLY METER INSTALLATION -RECORDING INDICATOR -OIL PRESSURE SWITCH	1200744-5 C664503-0101 S17111-1	0.6* 0.1 0.2	7.6* 17.5 -1.0

SECTION 6  
WEIGHT & BALANCE/  
EQUIPMENT LIST

CESSNA  
MODEL 182R

ITEM NO	EQUIPMENT LIST DESCRIPTION	REF DRAWING	WT LBS	ARM INS
D73-R	GAGE, MANIFOLD PRESSURE	C662035-0101	0.9	15.8
D82-S	GAGE, OUTSIDE AIR TEMPERATURE	C668507-0101	0.1	28.5
D85-R	TACHOMETER INSTALLATION, ENGINE -RECORDING TACH INDICATOR OR -RECORDING TACH IND. ALTERNATE	0706006 C668020-0117 C668020-0217	0.9* 0.7 0.7	12.4* 15.9 15.9
D88-S-1	INDICATOR, TURN COORDINATOR (28 VOLT ONLY)	C661003-0507	1.8	15.5
D88-S-2	INDICATOR, TURN COORDINATOR (10/30 VOLT)	C661003-0506	1.0	15.5
D88-0-1	INDICATOR TURN COORDINATOR (FOR NOM'S)	42320-0028	1.2	15.5
D88-0-2	INDICATOR, TURN & BANK	S-1303-2	1.0	15.5
D91-S	INDICATOR, VERTICAL SPEED E. CABIN ACCOMMODATIONS	C661080-0101	0.8	15.4
E05-R	SEAT, ADJUSTABLE FORE & AFT - PILOT	0714058-1	17.0	44.0
E05-0	SEAT, ARTICULATING VERT. ADJ. - PILOT	0714059-1	24.0	41.5
E07-S	SEAT, ADJUSTABLE FORE & AFT - CO-PILOT	0714058-1	17.0	44.0
E07-0	SEAT, ARTICULATING VERT. ADJ. - CO-PILOT	0714059-2	24.0	41.5
E09-S	SEAT, 2ND ROW BENCH	0714060-2	24.0	80.5
E11-A	SEAT INSTALLATION, AUXILIARY (CHILD'S) -SEAT ASSY, FOLDAWAY (120 LB MAX CAP.) -BELT ASSY, LAP	0501009-5 0714050-4 S1746-5	8.2* 6.9 0.9	104.2* 104.4 101.1
E15-R	BELT ASSY, LAP (PILOT SEAT)	S-2275-103	1.0	37.0
E15-S	SHOULDER HARNESS ASSY, PILOT	S-2275-201	0.6	37.0
E19-0	PILOT & CO-PILOT INERTIA REEL INSTL. (NET CHANGE)	0701139-1	2.0	71.6
E23-S	BELT & SHOULDER HARNESS ASSY, CO-PILOT	S-2275-3	1.0	37.0

ITEM NO	EQUIPMENT LIST DESCRIPTION	REF DRAWING	WT LBS	ARM INS
E27-S	BELT & SHOULDER HARNESS ASSY, 2ND ROW	S-2275-7	3.2	74.5
E35-A-1	INTERIOR, VINYL SEAT COVERS (NET CHANGE)	CES-1154	0.0	0.0
E35-A-2	INTERIOR, LEATHER SEAT COVERS (NET CHANGE)	CES-1154	2.0	62.3
E35-A-3	INTERIOR, SEAT COVERING--VINYL OR FABRIC AND LEATHER (NET CHANGE)	CES-1154	1.0	62.3
E35-A-4	INTERIOR, UPHOLSTERY SIDE PANEL LEATHER	CES-1154	1.0	65.0
E35-A-5	INTERIOR, UPHOLSTERY SIDE PANEL LEATHER AND VINYL OR FABRIC STYLING (NET CHANGE)	CES-1154	0.5	65.0
E36-A	FLOORMATS, REMOVABLE (SET OF 2)	0501120-1	3.8	21.0
E37-0	OPENABLE RH CABIN DOOR WINDOW (NET CHANGE)	0701065-8	2.3	47.0
E39-A	WINDOWS, OVERHEAD CABIN TOP (NET CHANGE)	0701017-11	0.6	45.5
E43-A	VENTILATION SYSTEM, 2ND ROW SEATING	2201117-1	2.3	49.1
E47-A	OXYGEN SYSTEM, 4 PORT -OXYGEN CYLINDER-EMPTY -OXYGEN - 48 CU FT @ 1800 PSI -OXYGEN MASKS, PILOT & 3 PASSENGER	2201006-10 C166001-0601 C166005	36.0* 25.0 4.0 1.5	133.6* 143.6 143.6 61.1
E49-A	CUP HOLDERS, RETRACTABLE (SET OF 2)	1201124	0.1	16.0
E50-A	HEADREST, 1ST ROW (INSTALLED ARM) (EACH)	1215073-1	0.9	47.0
E51-A	HEADREST, 2ND ROW (INSTALLED ARM) (EACH)	1215073-1	0.9	87.0
E55-S	SUN VISORS (SET OF 2)	0701024-1	1.0	33.0
E59-A	APPROACH PLATE HOLDER	0715083-1	0.1	22.0
E65-S	BAGGAGE TIE DOWN NET	1215171-1	0.5	108.0
E71-A	CARGO TIE DOWN LATCHES & SEAT RAIL CLAMPS (USE INSTALLED CARGO ARM)(STOWED) (NOT FACTORY INSTALLED)	0701029-1	1.2	



SECTION 6  
WEIGHT & BALANCE/  
EQUIPMENT LIST

CESSNA  
MODEL 182R

ITEM NO	EQUIPMENT LIST DESCRIPTION	REF DRAWING	WT LBS	ARM INS.
E85-S	FLIGHT CONTROLS, RH SIDE (DUAL) -PEDALS & TOE BRAKES	0760101 0760650-3	7.3	13.5
E89-0	CONTROL WHEEL, PILOT ALL PURPOSE (NET CHG)	1270747-3	0.0	0.0
E93-R	HEATING SYSTEM, CABIN & CARBURETOR AIR (INCLUDES ENGINE EXHAUST SYSTEM)	0750201	18.0	-16.0
F01-R	F. PLACARDS, WARNINGS & MANUALS			
F01-0-1	PLACARD, OPERATIONAL LIMITATIONS-VFR DAY	0505087-7	0.0	0.0
F01-0-2	PLACARD, OPERATIONAL LIMITATIONS-VFR DAY-NIGHT	0505087-8	0.0	0.0
F04-R	PLACARD, OPERATIONAL LIMITATIONS-- VFR-IFR/DAY-NIGHT	0505087-9	0.0	0.0
F10-S-1	INDICATOR, STALL WARNING HORN-AUDIBLE	1670056-1	1.0	17.5
F10-S-2	WARNING LIGHT, LOW VACUUM	S-2519-2	0.0	0.0
F13-S	WARNING LIGHT, LOW VOLTAGE, ALTERNATOR	S2519-2	0.0	0.0
F16-R	PILOT'S CHECK LIST (STOWED)	D6146	0.3	15.0
G01-A	PILOT'S OPERATING HANDBOOK AND FAA APPROVED AIRPLANE FLIGHT MANUAL, STOWED (NORMALLY STOWED IN PILOT SEAT POCKET AND INCLUDES THE FUSE STORAGE)	D1275-13PH	1.3	61.5
G04-A	G. AUXILIARY EQUIPMENT			
G07-A	TAILCONE LIFT HANDLES (SET OF 2)	2201009-1	1.0	186.5
G10-S	TOW HOOK (INSTALLED ARM SHOWN; NOMALLY STOWED, NOT FACTORY INSTALLED)	0500228-1	0.6	230.0
	HOISTING RINGS, AIRPLANE (NOT FACTORY INSTALLED)	07000612-1	1.5	45.6
	FUEL SAMPLER CUP (STOWED)	0756035-5	0.1	0.0

ITEM NO	EQUIPMENT LIST DESCRIPTION	REF DRAWING	WT LBS	ARM INS
G13-A	CORROSION PROOFING, INTERNAL	0760007-1	13.4	70.0
G16-A	STATIC DISCHARGERS (SET OF 10)	1201131-2	0.3	152.9
G19-A	STABILIZER ABRASION BOOTS	0500041-3	2.7	206.0
G22-S	TOWBAR, AIRCRAFT (STOWED ARM SHOWN)	0700315-4	1.6	97.0
G25-S	PAINT, OVERALL EXTERIOR, MODIFIED POLYURETHANE -OVERALL WHITE BASE -COLORED STRIPE	0704052	12.9*	92.9*
G31-A	CABLES, CORROSION RESISTANT (NET CHANGE)	0760007-1	0.0	0.0
G55-A-1	FIRE EXTINGUISHER, HAND TYPE (FOR USE WITH STANDARD PILOT SEAT) -FIRE EXTINGUISHER (GENERAL CORP) -BRACKETS & CLAMP	0701014-6 C421001-0201 C421001-0202	5.3* 4.8 0.5	35.0* 35.0 35.0
G55-A-2	FIRE EXTINGUISHER, HAND TYPE (FOR USE WITH VERTICAL ADJUSTING PILOT SEAT) -FIRE EXTINGUISHER (GENERAL CORP) -BRACKETS & CLAMP	1201177-1 C421001-0201	5.6* 4.8 0.8	29.0* 29.0 29.0
G58-A	REFUELING ASSIST STEPS & HANDLES (2)	0701127-1	1.8	15.3
G61-A	WRITING TABLE	1715072-1	6.5	61.5
G67-A	PEDAL EXTENSIONS, RUDDER, REMOVABLE - SET OF 2 (STOWABLE - INSTALLED ARM SHOWN) (NOT FACTORY INSTALLED)	0501082-1	2.9	8.0
G89-A	WINTERIZATION KIT, ENGINE -WINTER FRONT (ARM SHOWN)	0752647-15	1.1* 0.5	-29.9* -34.3

SECTION 6  
WEIGHT & BALANCE/  
EQUIPMENT LIST

CESSNA  
MODEL 182R

ITEM NO	EQUIPMENT LIST DESCRIPTION	REF DRAWING	WT LBS	ARM INS
H01-A-1	H. AVIONICS & AUTOPILOTS SPERRY 546E ADF INSTALLATION W/BFO -RECEIVER WITH BFO (R-546E) -INDICATOR, IN-346A -ADF LOOP ANTENNA -SENSE ANTENNA INSTL. -MOUNTING BOX & MISC ITEMS	3910159-1 41240-0001 40980-1001 41000-1000 3960140-1	7.7* 3.5 0.9 1.4 0.3 1.8	22.6* 13.5 15.5 40.9 107.9 14.9
H01-A-2	SPERRY 646A ADF INSTALLATION W/BFO -RECEIVER WITH DUAL SELECTOR (R-446A) -INDICATOR, IN-346A -ADF LOOP ANTENNA -SENSE ANTENNA INSTL. -MOUNTING BOX & MISC ITEMS	3910160-1 43090-1028 40980-1001 41000-1000 3960140-1	7.7* 3.3 0.9 1.4 0.3 1.8	22.6* 13.5 15.5 40.9 107.9 14.9
H03-A	AM/FM STEREO RECEIVER & CASSETTE PLAYER -HEADSET (SET OF 2, 4 MAY BE USED) (ARM IS FOR OCCUPANT POSITION) -STEREO RECEIVER INSTL. -ANTENNA & MISC ITEMS	3910209-1 C596532-0101 3930211-1	6.0* 2.2 1.4	30.5* 37.0 49.4
H04-A-1	SPERRY 477A DME INSTALLATION -RECEIVER/TRANSMITTER, RTA-477A -CONTROL UNIT, C-477A & MOUNT -ANTENNA -WIRING & MISC HARDWARE	3910228-1 50950-0000 50930-0000 42940-0000	10.8* 5.0 1.5 0.2 4.1	89.4* 136.2 13.0 28.9 60.3
H04-A-2	SPERRY 476A DME INSTL. (FOR EXPORT USE) -RECEIVER/TRANSMITTER, RT-476A -INDICATOR -ANTENNA -WIRING & MISC. HARDWARE	3910167 44000-0000 44020-1000 42940-0000	14.9* 9.0 1.5 0.2 4.1	104.2* 135.2 13.0 88.4 60.3
H04-A-3	SPERRY 377A DME INSTALLATION -TRANSCIVER/INDICATOR, SPERRY RT-377A -MOUNTING TRAT, SPERRY -ANTENNA, SPERRY 42940-0000 -CABLE INSTALLATION	3910241 51670-0001 50713-0003 C589507-0201 3950122-47	3.2* 2.0 0.3 0.2 0.7	13.5* 11.9 10.3 32.0 12.7

ITEM NO	EQUIPMENT LIST DESCRIPTION	REF DRAWING	WT LBS	ARM INS
H05-A-1	SPERRY 479A R-NAV INSTALLATION (INCLUDES INDICATORS) (NET CHANGE) -R-NAV COMPUTER, RN-479A -INDICATOR ADDED, IN-482AC -INDICATOR DELETED, IN-380A -WIRING & HARDWARE	3910168-18 50960-0000 50570-1310 50570-1300	5.0* 4.7 1.5 -1.7 0.5	11.3* 11.5 15.5 15.5 11.1
H05-A-2	SPERRY 478A R-NAV INSTALLATION (INDICATORS) (NET CHANGE) (EXPORT USE) -R-NAV COMPUTER, R-478A -INDICATOR, IN-442AR ADDED -INDICATOR, IN-385A DELETED -COOLING, WIRING & HARDWARE	3910168-4 44100-1000 43910-1000 46850-1000 3930253-5	4.7* 4.7 1.0 -1.7 1.1	10.7* 11. 15. 15. 19.0
H07-A-1	SPERRY 443B GLIDESLOPE INSTL., (INCLUDES VOR/ILS IND., EXCHANGE FOR VOR/LOC IND.) -RECEIVER, R-443B -RECEIVER MOUNT -ANTENNA COUPLER (WT NET CHG) -VOR/ILS INDICATOR, IN-381A ADDED -VOR/LOC INDICATOR, IN-380A DELETED	3910157-6 42100-0000 36450-0000 50570-2000 50570-1000	3.7* 2.1 0.3 0.0 +1.5 -1.4	109.9* 130.1 130.1 0.0 15.5 15.5
H07-A-2	SPERRY 443B GLIDESLOPE INSTL (EXPORT ONLY) (INCL VOR/ILS IND., EXCHANGE FOR VOR/LOC -RECEIVER, 40.0 -RECEIVER MOUNT -ANTENNA COUPLER (WT NET CHG) -VOR/ILS INDICATOR, IN-386A ADDED -VOR/LOC INDICATOR, IN-385A DELETED	3910157-6 42100-0000 36450-0000 46860-2000 46860-1000	3.8* 2.1 0.3 0.0 1.8 -1.7	109.9* 130.1 130.1 0.0 15.5 15.5
H08-A-1	AUTO RADIAL CENTERING INDICATOR ARC/LOC EXCHANGE FOR VOR/LOC IN ITEMS H22-A-1 AND H22-A-2 (WT NET CHANGE) -ARC/LOC INDICATOR ADDED, IN-380AC -VOR/LOC INDICATOR DELETED, IN-380A	3910196-3 50570-1200 50570-1000	0.1* +1.5 -1.4	15.5* 15.5 15.5
H08-A-2	AUTO RADIAL CENTERING INDICATOR ARC/ILS EXCHANGE FOR VOR/ILS INDICATOR IN ITEM H07-A ONLY -ARC/ILS INDICATOR ADDED, IN-381AC -VOR/ILS INDICATOR DELETED, IN-381A	3910196-4 50570-2200 50570-2000	0.2* +1.6 -1.4	15.5* 15.5 15.5

SECTION 6  
WEIGHT & BALANCE/  
EQUIPMENT LIST

CESSNA  
MODEL 182R

ITEM NO	EQUIPMENT LIST DESCRIPTION	REF DRAWING	WT LBS	ARM INS
H09-A	UNSLAVED HSI INSTALLATION (USED WITH H31-A-3 AUTOPILOT ONLY) -HSI GYRO, NON-SLAVED -CONTROLLER (NET CHANGE) -CONVERTER INSTALLATION -VOR/LOC INDICATOR IN-380A DELETED	3910195-4  3930165 3940269-1 50570-1000	3.5* 5.2 0.1 1.2 -1.4	84.9* 13.0 14.0 178.4 15.5
H11-A	SUNAIR ASB-125 SSB HF TRANSCEIVER INSTL., (2ND UNIT) -RE-1000 SINGLE SIDE BAND XCVR, ASB-125 -PA-1010A REMOTE POWER AMPLIFIER -CU-10 ANTENNA COUPLER (LOAD BOX) -ANTENNA INSTL, 351 INCH LONG -WIRING & MISC. ITEMS	3910158-9  99681 99391 99816 3960117	22.8* 5.3 7.5 4.9 0.4 4.7	88.7* 12.7 128.3 121.0 180.2 169.7
H13-A-1	SPERRY 402B MARKER BEACON INSTALLATION -RECEIVER, R-402B -ANTENNA, FLUSH MOUNTED IN TAILCONE -WIRING & MISC. HARDWARE	3910164-5 51170-0000 1270720-13	2.3* 0.8 1.0 0.6	74.7* 11.5 133.4 52.2
H13-A-2	SPERRY 402A MARKER BEACON INSTL. (EXPORT ONLY) -RECEIVER, R-402A -ANTENNA, FLUSH MOUNTED IN TAILCONE	3910164 42410-5128 1270720-13	2.4* 0.7 1.0	72.1* 11.5 133.4
H16-A-1	SPERRY 359A TRANSPONDER INSTALLATION -RECEIVER-TRANSMITTER (RT-359A) -ANTENNA -COOLING INSTALLATION -WIRING & MISC. HARDWARE	3910127-19 41420-0028 42940-0000 3930253-4	4.6* 2.7 0.2 0.2 1.3	31.0* 11.5 167.0 6.0 54.4
H16-A-2	SPERRY 459A TRANSPONDER INSTALLATION -RECEIVER-TRANSMITTER (RT-459A) -ANTENNA -COOLING INSTALLATION -WIRING & MISC. HARDWARE	3910128-13 41470-1028 42940-0000 3930253-4	4.5* 2.8 0.2 0.2 1.3	30.7* 11.5 167.0 6.0 50.0
H22-A-1	SPERRY 385A NAV/COM 720 CHANNEL COM INSTL REQUIRES--H37-A TO BE 1ST UNIT H37-A TO BE 2ND UNIT -RECEIVER-TRANSCIEVER (RT-385A) -VOR/LOC INDICATOR (IN-380A) -MOUNT, WIRING & MISC HARDWARE	3910183-16,-19  46660-1000 50570-1000	7.6* 5.5 1.4 0.7	12.0* 11.5 15.5 8.9

CESSNA  
MODEL 182R

SECTION 6  
WEIGHT & BALANCE/  
EQUIPMENT LIST

ITEM NO	EQUIPMENT LIST DESCRIPTION	REF DRAWING	WT LBS	ARM INS
H22-A-2	SPERRY 385A OR 485A NAV/COM (EXPORT ONLY) REQUIRES--H34-A TO BE 1ST UNIT H37-A TO BE 2ND UNIT -RECEIVER/TRANSCIVER, RT-485A OR -385A -VOR/LOC INDICATOR, IN-385A	3910189 47360-1000 46860-1000	7.8* 5.5 1.7	12.2* 11.5 15.5
H22-A-3	SPERRY 485B NAV/COM 720 CHANNEL COM INSTL REQUIRES--H34-A TO BE 1ST UNIT H37-A TO BE 2ND UNIT -RECEIVER/TRANSCIVER (RT-485B) -VOR/LOC INDICATOR (IN-380A) -MOUNT, WIRING AND MISC HARDWARE	3910222-2 49250-1000 50570-1000	7.6* 5.5 1.4 0.7	12.0* 11.5 15.5 8.9
H28-A	EMERGENCY LOCATOR TRANSMITTER INSTL. -TRANSMITTER ASSY, DMELT-8 -ANTENNA -MISC. HARDWARE	0701135 C582512-0103 C583512-0106	3.0* 3.7 0.2 0.1	152.6* 151.5 168.0 151.5
H31-A-1	SPERRY 200A AUTOPILOT INSTL. (AF-295B) -CONTROLLER-AMPLIFIER -D88-0-1 TURN COORDINATOR ADDED -WING SERVO INSTALLATION -D88-S-1 TURN COORDINATOR DELETED	3910162-15 43610-1202 42320-0028 0700215 C661003-0506	8.4* 1.1 1.2 5.2 -1.0	51.9* 14.0 15.5 73.4 15.5
H31-A-2	SPERRY 300A AUTOPILOT INSTL (AF-395-A) -CONTROLLER-AMPLIFIER (C-395A) -GYRO INSTALLATION (NET CHANGE) -D88-0-1 TURN COORDINATOR ADDED -WING SERVO INSTALLATION -D88-S-1 TURN COORDINATOR DELETED	3910163-15 42660-1202 -0706008-2 42320-0028 0700215 C661003-0506	8.9* 1.4 0.2 1.2 5.2 -1.0	49.9* 14.0 12.4 15.5 73.4 15.5
H31-A-3	SPERRY 300A AUTOPILOT, NON-SLAVED HSI INCLUDES THE FOLLOWING ITEMS-- -H03-A UNSLAVED HSI -H31-A-2 NAV-O-MATIC 300A	3910195 3910195-4 3910163-15	12.4* 3.5 8.9	59.8* 84.9 49.9

Original Issue

6-27

SECTION 6  
WEIGHT & BALANCE/  
EQUIPMENT LIST

CESSNA  
MODEL 182R

ITEM NO	EQUIPMENT LIST DESCRIPTION	REF DRAWING	WT LBS	ARM INS
H33-A	INTERCOM SYSTEM INSTALLATION REQUIRES E39-0, ALL PURPOSE CONTROL WHEEL -JACK INSTALLATION FOR INTERCOM-RH SIDE -H56-A HEADPHONE-MIKE (SET OF 2) (OCCUPANT USAGE ARM SHOWN) -INTERCOM P/C BOARD ASSY -RH CONTROL WHEEL INSTL (NET CHANGE) -DELETE HEADPHONE FROM BASIC AV. KIT	3910210-7  C596531-0101 3970149-1 3970153-7	2.7* 0.1 2.2 0.2 0.3 -0.3	34.0* 17.6 37.0 15.0 20.4 18.5
H34-A	BASIC AVIONICS KIT INSTALLATION REQUIRED WITH 1ST UNIT NAV/COM -CABIN SPEAKER INSTL. -BUSSBAR INSTALLATION -RADIO COOLING FAN INSTL -RADIO COOLING TUBING -NOISE FILTER (ON ALTERNATOR) -RECEIVER INSTALLATION KIT -FUSE HOLDER -CABLE FOR COM ANTENNA -OMNI ANTENNA -COM ANTENNA INSTALLATION -AUDIO CONTROL PANEL AND WIRING -HEADSET INSTALLATION -MICROPHONE INSTALLATION -ANTENNA ADAPTER INSTALLATION -G16-A STATIC DISCHARGER KIT	3910186-8  0770750-741 3930178-6 3930253-8 3940148-2 3930260-4 3940260-1 3950126-60 3950126-51 3960142-6 3960113-2 3970152-1 3970161-2 3970139-1 3960131-2 1201131-2	8.1* 1.9 0.0 1.1 0.1 0.1 0.2 0.1 0.3 1.0 0.5 0.5 1.1 0.3 0.3 0.1 0.3	57.3* 45.1 0.0 3.2 7.0 -6.0 14.8 130.0 133.8 126.8 244.7 63.3 15.5 18.5 15.0 152.9
H37-A	ANTENNA & COUPLER KIT (ROD & AVAILABLE WITH 2ND NAV/COM INSTL.) -ANTENNA & CABLE, LH VHF COM -ANTENNA CABLE INSTALLATION -RADIO COOLING TUBING	3910185-6  3960111-8 3930253-2	1.3* 0.8 0.2 0.1	32.0* 47.2 5.0 7.0
H43-A-1	SPERRY 200A AUTOPILOT PARTIAL INSTL (NOT AVAILABLE W/ FACTORY INSTALLED NAV/COMS) -ROLL ACTUATOR INSTALLATION -COMPUTER AND TURN COORDINATOR INSTL -CABLE INSTL. --WING AREA -CABLE INSTL. --INSTRUMENT PANEL AREA -D88-S-2 TURN COORDINATOR DELETED	3910154-109  0700215-5 3930144-2 3950115-6 3950148-5 C661003-0506	8.1* 5.2 3.0 0.5 0.5 -1.0	53.4* 73.4 14.8 32.8 19.4 15.5

ITEM NO	EQUIPMENT LIST DESCRIPTION	REF DRAWING	WT LBS	ARM INS
H43-A-2	SPERRY 300A AUTOPILOT PARTIAL INSTL (NOT AVAILABLE W/ FACTORY INSTALLED NAV/COMS) -ROLL ACTUATOR INSTALLATION -COMPUTER INSTL (INCLUDES GYROS & TURN COORDINATOR NET CHANGE) -CABLE INSTL.--WING AREA -CABLE INSTL.--INSTRUMENT PANEL AREA	3910154-119 0700215 3930145-4 3950115-6 3950148-6	8.7* 5.2 2.4 0.6 0.6	50.8* 73.4 14.4 32.0 18.4
H46-A	ADF ANTI PRECIP SENSE ANTENNA	3910154-64	0.8	141.8
H55-A	MIC-HEADSET COMBINATION, LIGHT WT REQUIRES E89-0 INSTALLATION (STOWED)	C596533-010J	0.2	12.0
H56-A-1	HEADSET-MICROPHONE, PADDED (STOWED) (REQUIRES E89-0 INSTALLATION)	C596531-0101	1.1	14.0
H56-A-2	2ND ROW STEREO HEADSET (SET OF 2)	C596532-0101	2.2	74.5
H58-A	AUDIO CONTROL PANEL WITH 3RD XMTR SWITCH EXCHANGE FOR PANEL WITH 2 XMTR SWITCHES WT - NET CHANGE	3970129	0.0	0.0
H64-A	AVIONICS OPTION A, PROVISIONS FOR SINGLE NAV/COM, AVAILABLE ON EXPORT A/C ONLY -CABIN SPEAKER -RADIO COOLING BLOWER -CABLE, RH VHF COM ANTENNA -CABLE, FOR OMNI ANTENNA -COM ANTENNA, VHF, RH SIDE -OMNI ANTENNA (LOCATED ON VERTICAL FIN) -HEADPHONE INSTALLATION -MIKE INSTALLATION	3910206-11 0770750-741 3930253-8 3950126-40 3950126-51 3920113-2 3950142-5 3970161-2 3970139-1	5.9* 1.9 1.1 0.3 1.0 0.5 0.5 0.3 0.3	65.7* 45.1 3.5 23.9 126.8 63.3 244.7 13.5 18.5
H67-A	AVIONICS OPTION B, DUAL NAV/COM PROVISIONS FOR EXPORT AIRCRAFT ONLY -H64-A AVIONICS OPTION A -CABLE ASSY, LH VHF COM ANTENNA -ANTENNA INSTL., LH VHF COM	3910206-12 3910206 3950126-41 3960113-1	6.7* 5.9 0.5 0.5	63.6* 65.7 23.9 63.3
H70-A	REMOTE TRANSPONDER IDENT SWITCH	3910205-1	0.1	17.0



SECTION 6  
WEIGHT & BALANCE/  
EQUIPMENT LIST

CESSNA  
MODEL 182R

ITEM NO	EQUIPMENT LIST DESCRIPTION	REF DRAWING	WT LBS	ARM INS
J01-A	<p>J. SPECIAL OPTION PACKAGES</p> <p>SKYLANE VALUE GROUP A EQUIPMENT PACKAGE            -C07-A GROUND SERVICE RECEP TACLE            -C19-O HEATED PILOT &amp; STALL WARNING            -C31-A COURTESY ENTRANCE LIGHTS (2)            -C40-A NAV LIGHT DETECTORS (2)            -C43-A FLASHING BEACON LIGHT            -D01-O TRUE AIRSPEED IND. NET CHANGE            -D04-A STUTIC ALTERNATE AIR SOURCE            -D49-A EGT (ECONOMY MIXTURE)            -H01-A-1 SPERRY 300 ADF (R-546E)            -H16-A-1 SPERRY 300 TRANSPONDER RT-359A            -H22-A-1 SPERRY 300 NAV/COM CRT-352AJ            -H28-A EMERGENCY LOCATOR TRANSMITTER            -H31-A-1 SPERRY 200A AUTO-PILOT            -H34-A BASIC AVIONICS KIT</p>	<p>2270017-2            2770224-2            0700615-11            0701013-1, -2            0701042-2            1201108-21            1201108-21            07500609-2            3910159-1            3910127-6            3910183-16            0701135            3910162-15            3910186-8</p>	<p>46.2*            3.1            0.5            0.0            0.0            1.8            0.3            0.7            0.7            4.4            7.6            3.0            8.4            8.1</p>	<p>56.7*            128.9            29.5            61.7            0.0            208.6            164.5            14.4            22.6            21.0            122.6            51.8            57.3</p>
J04-A	<p>SKYLANE VALUE GROUP B EQUIPMENT PACKAGE            -H07-A-1 SPERRY 400 GLIDESLOPE R-443B            -H13-A-1 SPERRY 400 MARKER BEACON            -H22-A-1 NAV/COM, 2ND UNIT            -H37-A ANTENNA &amp; COUPLER KIT</p>	<p>3910157            3910164-5            3910183-19            3910185-6            0700615-11</p>	<p>14.2*            2.7            2.2            7.6            1.3            0.5</p>	<p>47.7*            109.9            74.7            122.0            32.0            61.7</p>

# SECTION 7 AIRPLANE & SYSTEMS DESCRIPTIONS

## TABLE OF CONTENTS

	Page
Introduction . . . . .	7-3
Airframe . . . . .	7-3
Flight Controls . . . . .	7-8
Trim Systems . . . . .	7-8
Instrument Panel . . . . .	7-8
Ground Control . . . . .	7-9
Wing Flap System . . . . .	7-10
Landing Gear System . . . . .	7-11
Baggage Compartment . . . . .	7-11
Seats . . . . .	7-11
Seat Belts And Shoulder Harnesses . . . . .	7-12
Seat Belts . . . . .	7-12
Shoulder Harnesses . . . . .	7-14
Integrated Seat Belt/Shoulder Harnesses With Inertia Reels . . . . .	7-14
Entrance Doors And Cabin Windows . . . . .	7-15
Control Locks . . . . .	7-16
Engine . . . . .	7-16
Engine Controls . . . . .	7-16
Engine Instruments . . . . .	7-17
New Engine Break-In And Operation . . . . .	7-18
Engine Lubrication System . . . . .	7-18
Ignition-Starter System . . . . .	7-19
Air Induction System . . . . .	7-19
Exhaust System . . . . .	7-20
Carburetor And Priming System . . . . .	7-20
Cooling System . . . . .	7-20
Propeller . . . . .	7-21
Fuel System . . . . .	7-21
Brake System . . . . .	7-25
Electrical System . . . . .	7-25
Master Switch . . . . .	7-27
Avionics Power Switch . . . . .	7-27
Ammeter . . . . .	7-27

**TABLE OF CONTENTS (Continued)**

	Page
Alternator Control Unit And Low-Voltage Warning Light . . .	7-28
Circuit Breakers And Fuses . . . . .	7-28
Ground Service Plug Receptacle . . . . .	7-29
Lighting Systems . . . . .	7-29
Exterior Lighting . . . . .	7-29
Interior Lighting . . . . .	7-29
Cabin Heating, Ventilating And Defrosting System . . . . .	7-31
Pitot-Static System And Instruments . . . . .	7-33
Airspeed Indicator . . . . .	7-34
Vertical Speed Indicator . . . . .	7-34
Altimeter . . . . .	7-34
Vacuum System And Instruments . . . . .	7-34
Attitude Indicator . . . . .	7-36
Directional Indicator . . . . .	7-36
Suction Gage . . . . .	7-36
Low-Vacuum Warning Light . . . . .	7-36
Outside Air Temperature (OAT) Gage . . . . .	7-37
Stall Warning System . . . . .	7-37
Avionics Support Equipment . . . . .	7-37
Avionics Cooling Fan . . . . .	7-37
Microphone - Headset Installations . . . . .	7-38
Static Dischargers . . . . .	7-38
Cabin Features . . . . .	7-39
Cabin Fire Extinguisher . . . . .	7-39

## INTRODUCTION

This section provides description and operation of the airplane and its systems. Some equipment described herein is optional and may not be installed in the airplane. Refer to Section 9, Supplements, for details of other optional systems and equipment.

## AIRFRAME

The airplane is an all-metal, four-place, high-wing, single-engine airplane equipped with tricycle landing gear and designed for general utility purposes.

The construction of the fuselage is a conventional formed sheet metal bulkhead, stringer, and skin design referred to as semimonocoque. Major items of structure are the front and rear carry-through spars to which the wings are attached, a bulkhead and forgings for main landing gear attachment at the base of the rear door posts, and a bulkhead with attaching plates at the base of the forward door posts for the lower attachment of the wing struts. Four engine mount stringers are also attached to the forward door posts and extend forward to the firewall.

The externally braced wings, containing the fuel tanks, are constructed of a front and rear spar with formed sheet metal ribs, doublers, and stringers. The entire structure is covered with aluminum skin. The front spars are equipped with wing-to-fuselage and wing-to-strut attach fittings. The aft spars are equipped with wing-to-fuselage attach fittings, and are partial-span spars. Conventional hinged ailerons and single-slot type flaps are attached to the trailing edge of the wings. The ailerons are constructed of a forward spar containing balance weights, formed sheet metal ribs and "V" type corrugated aluminum skin joined together at the trailing edge. The flaps are constructed basically the same as the ailerons, with the exception of balance weights and the addition of a formed sheet metal leading edge section.

The empennage (tail assembly) consists of a conventional vertical stabilizer, rudder, horizontal stabilizer, and elevator. The vertical stabilizer consists of a forward and aft spar, formed sheet metal ribs and reinforcements, four skin panels, formed leading edge skins, and a dorsal. The rudder is constructed of a forward and aft spar, formed sheet metal ribs and reinforcements, and a wrap-around skin panel. The top of the rudder incorporates a leading edge extension which contains a balance weight. The horizontal stabilizer is constructed of a forward and aft spar, ribs and stiffeners, center upper and lower skin panels, and two left and two right wrap-around skin panels which also form the leading edges. The horizon-

**AILERON CONTROL SYSTEM**

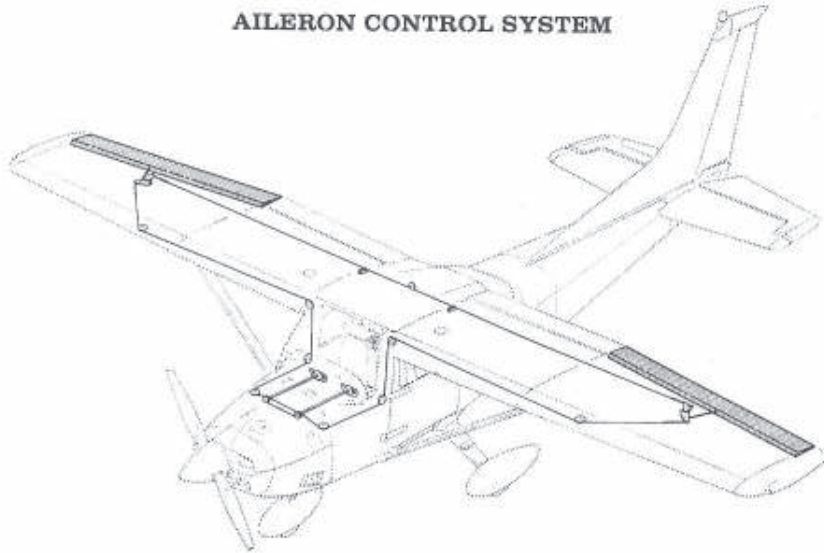

**RUDDER AND RUDDER TRIM CONTROL SYSTEMS**

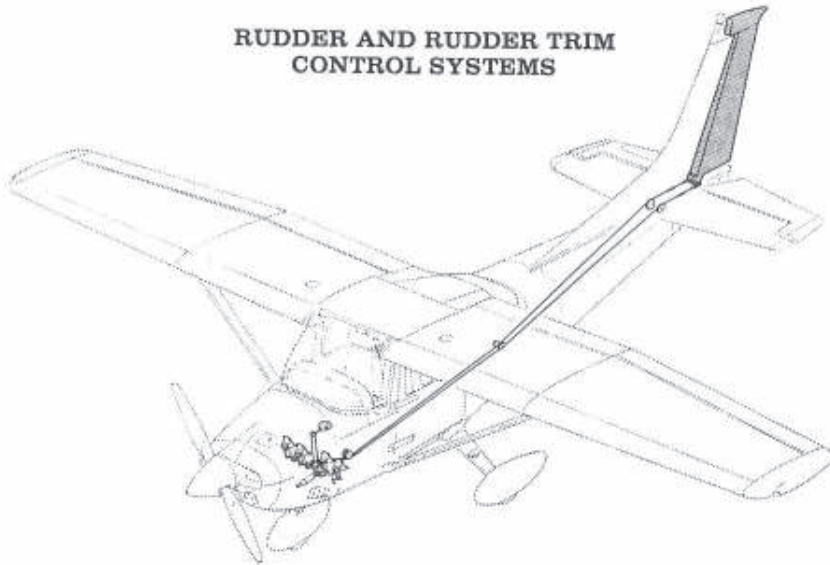
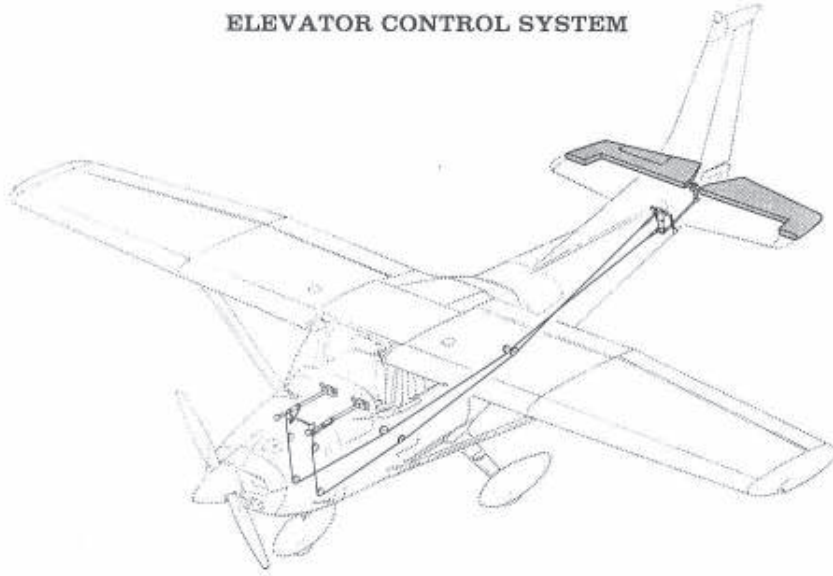

Figure 7-1. Flight Control and Trim Systems (Sheet 1 of 2)

**ELEVATOR CONTROL SYSTEM**



**ELEVATOR TRIM CONTROL SYSTEM**

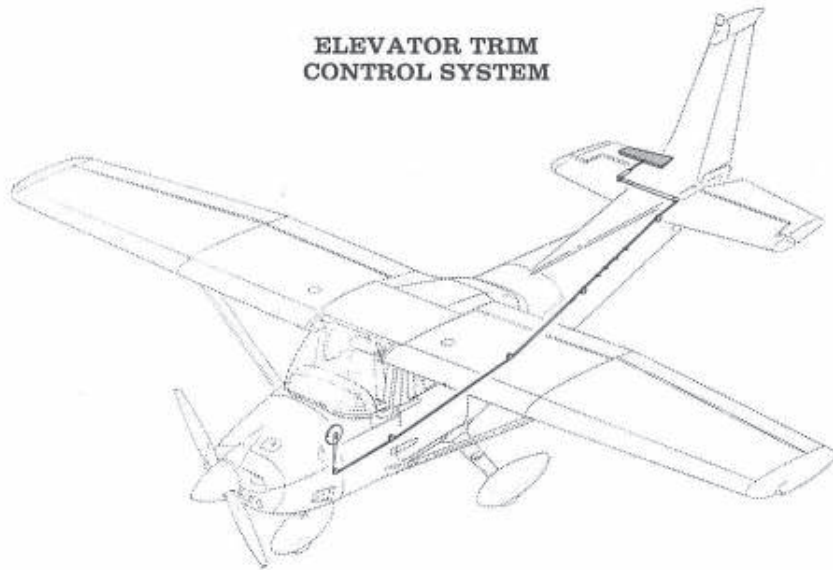

Figure 7-1. Flight Control and Trim Systems (Sheet 2 of 2)

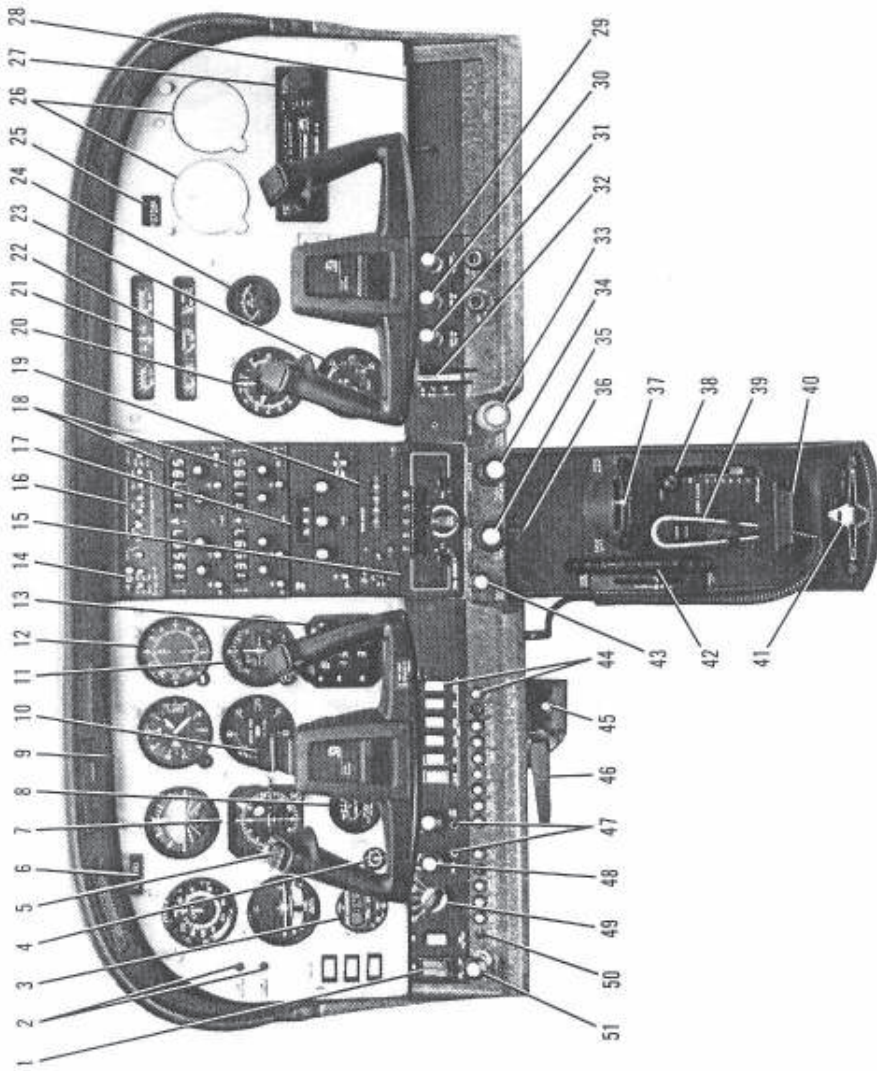

Figure 7-2. Instrument Panel (Sheet 1 of 2)

- |  |  |
|--|--|
| 1. Master Switch   | 27. Cassette Stereo, AM/FM Entertainment Center        |
| 2. Low-Voltage and Low-Vacuum Warning Lights                           | 28. Map Compartment                                    |
| 3. Digital Clock   | 29. Defroster Control                                  |
| 4. Suction Gage  | 30. Cabin Air Control                                  |
| 5. Electric Elevator Trim Switch                                       | 31. Cabin Heat Control                                 |
| 6. Airplane Registration Number  | 32. Wing Flap Switch and Position Indicator            |
| 7. Flight Instrument Group   | 33. Mixture Control                                    |
| 8. Carburetor Air Temperature Gage                                     | 34. Propeller Control                                  |
| 9. Approach Plate Light and Switch                                     | 35. Throttle (With Friction Lock)                      |
| 10. Approach Plate Holder  | 36. Control Pedestal Light                             |
| 11. Course Deviation Indicator   | 37. Rudder Trim Control Wheel and Position Indicator   |
| 12. ADF Bearing Indicator  | 38. Cowl Flap Control Lever                            |
| 13. DME  | 39. Microphone   |
| 14. Marker Beacon Indicator Lights and Switches                        | 40. Fuel Selector Light                                |
| 15. Autopilot Control Unit   | 41. Fuel Selector Valve Handle                         |
| 16. Audio Control Panel  | 42. Elevator Trim Control Wheel and Position Indicator |
| 17. ADF Radio  | 43. Carburetor Heat Control                            |
| 18. Nav/Com Radios   | 44. Electrical Switches and Circuit Breakers           |
| 19. Transponder  | 45. Static Pressure Alternate Source Valve             |
| 20. Manifold Pressure Gage   | 46. Parking Brake Handle                               |
| 21. Fuel Quantity Indicators and Ammeter                               | 47. Auxiliary Phone and Mike Jacks                     |
| 22. Cylinder Head Temperature, Oil Temperature, and Oil Pressure Gages | 48. Instrument and Radio Dial Lights Dimming Rheostats |
| 23. Tachometer   | 49. Ignition Switch                                    |
| 24. Economy Mixture Indicator (EGT)                                    | 50. Standby Vacuum Pump Switch                         |
| 25. Flight Hour Recorder   | 51. Manual Primer                                      |
| 26. Additional Instrument Space  |  |

Figure 7-2. Instrument Panel (Sheet 2 of 2)



tal stabilizer also contains the elevator trim tab actuator. Construction of the elevator consists of formed leading edge skins, a forward spar, ribs, torque tube and bellcrank, left upper and lower "V" type corrugated skins, and right upper and lower "V" type corrugated skins incorporating a trailing edge cut-out for the trim tab. The elevator trim tab consists of a spar and upper and lower "V" type corrugated skins. Both elevator tip leading edge extensions incorporate balance weights.

## FLIGHT CONTROLS

The airplane's flight control system (see figure 7-1) consists of conventional aileron, rudder, and elevator control surfaces. The control surfaces are manually operated through mechanical linkage using a control wheel for the ailerons and elevator, and rudder/brake pedals for the rudder. The elevator control system is equipped with downsprings which provide improved stability in flight.

Extensions are available for the rudder/brake pedals. They consist of a rudder pedal face, two spacers and two spring clips. To install an extension, place the clip on the bottom of the extension under the bottom of the rudder pedal and snap the top clip over the top of the rudder pedal. Check that the extension is firmly in place. To remove the extensions, reverse the above procedures.

## TRIM SYSTEMS

Manually-operated rudder and elevator trim is provided (see figure 7-1). Rudder trimming is accomplished through a bungee connected to the rudder control system and a trim control wheel mounted on the control pedestal. Rudder trimming is accomplished by rotating the horizontally mounted trim control wheel either left or right to the desired trim position. Rotating the trim wheel to the right will trim nose-right; conversely rotating it to the left will trim nose-left. Elevator trimming is accomplished through the elevator trim tab by utilizing the vertically mounted trim control wheel. Forward rotation of the trim wheel will trim nose-down; conversely, aft rotation will trim nose-up. The airplane may also be equipped with an electric elevator trim system. For details concerning this system, refer to Section 9, Supplements.

## INSTRUMENT PANEL

The instrument panel (see figure 7-2) is designed around the basic "T" configuration. The gyros are located immediately in front of the pilot, and

arranged vertically. The airspeed indicator and altimeter are located to the left and right of the gyros, respectively. The remainder of the flight instruments are located around the basic "T". Warning lights for low-voltage and low-vacuum are located on the left side of the instrument panel. Avionics equipment is stacked approximately on the centerline of the panel, with the right side of the panel containing the manifold pressure gage, tachometer, map compartment, and space for additional instruments and avionics equipment. The engine instrument cluster and fuel quantity indicators are on the right side of the avionics stack near the top of the panel. A switch and control panel, at the lower edge of the instrument panel, contains most of the switches, controls, and circuit breakers necessary to operate the airplane. The left side of the panel contains the avionics cooling fan fuse, master switch, engine primer, ignition switch, avionics power switch, light intensity controls, electrical switches, and circuit breakers. The center area contains the carburetor heat control, throttle, propeller control, and mixture control. The right side of the panel contains the wing flap switch and position indicator, and cabin heat, cabin air, and defroster control knobs. A pedestal, extending from the switch and control panel to the floorboard, contains the elevator and rudder trim control wheels, cowl flap control lever, and microphone bracket. The fuel selector valve handle is located at the base of the pedestal. A parking brake handle is mounted below the switch and control panel, in front of the pilot. A static pressure alternate source valve control knob may also be installed below the switch and control panel adjacent to the parking brake handle.

For details concerning the instruments, switches, circuit breakers, and controls on this panel, refer in this section to the description of the systems to which these items are related.

## GROUND CONTROL

Effective ground control while taxiing is accomplished through nose wheel steering by using the rudder pedals; left rudder pedal to steer left and right rudder pedal to steer right. When a rudder pedal is depressed, a spring-loaded steering bungee (which is connected to the nose gear and to the rudder bars) will turn the nose wheel through an arc of approximately 11° each side of center. By applying either left or right brake, the degree of turn may be increased up to 29° each side of center.

Moving the airplane by hand is most easily accomplished by attaching a tow bar to the nose gear strut. The tow bar is stowed under the rear seat using two clips, one attached to the center leg of the seat and one secured to the floorboard under the left side of the seat. If a tow bar is not available, or pushing is required, use the wing struts as push points. Do not use the vertical or horizontal surfaces to move the airplane. If the airplane is to be towed by vehicle, never turn the nose wheel more than 29° either side of center or structural damage to the nose gear could result.

The minimum turning radius of the airplane, using differential braking and nose wheel steering during taxi, is approximately 27 feet. To obtain a minimum radius turn during ground handling, the airplane may be rotated around either main landing gear by pressing down on a tailcone bulkhead just forward of the horizontal stabilizer to raise the nose wheel off the ground.

## WING FLAP SYSTEM

The single-slot type wing flaps (see figure 7-3), are extended or retracted by positioning the wing flap switch lever on the right side of the switch and control panel to the desired flap deflection position. The switch lever is moved up or down in a slotted panel that provides mechanical stops at the 10° and 20° positions. For flap settings greater than 10°, move the switch lever to the right to clear the stop and position it as desired. A scale and pointer on the left side of the switch lever indicates flap travel in degrees. The wing flap system circuit is protected by a 10-amp "push-to-reset" circuit breaker, labeled FLAP, on the left side of the switch and control panel.

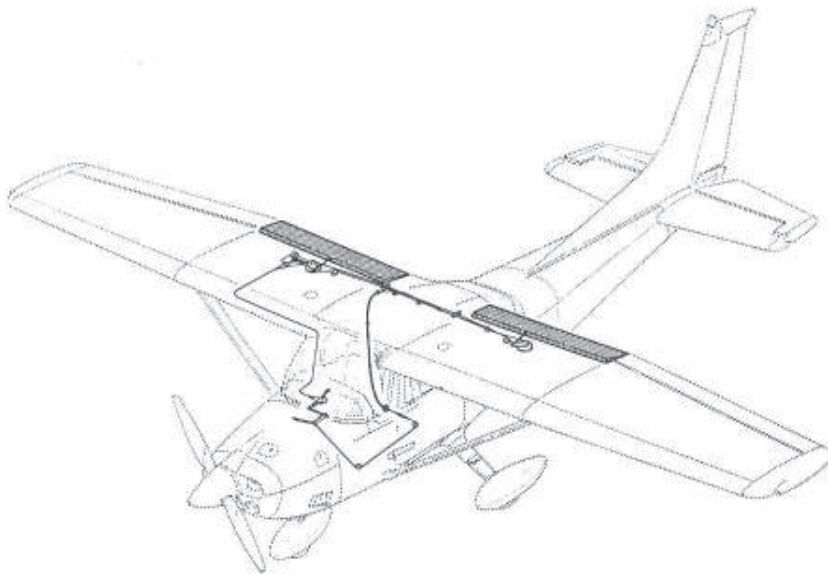

Figure 7-3. Wing Flap System

## LANDING GEAR SYSTEM

The landing gear is of the tricycle type with a steerable nose wheel and two main wheels. The landing gear may be equipped with wheel fairings. Shock absorption is provided by the tubular spring-steel main landing gear struts and the air/oil nose gear shock strut. Each main gear wheel is equipped with a hydraulically actuated single-disc brake on the inboard side of each wheel. When wheel fairings are installed, an aerodynamic fairing covers each brake.

## BAGGAGE COMPARTMENT

The baggage compartment consists of the area from the back of the rear passenger seats to the aft cabin bulkhead. Access to the baggage compartment is gained through a lockable baggage door on the left side of the airplane, or from within the airplane cabin. A baggage net with six tie-down straps is provided for securing baggage and is attached by tying the straps to tie-down rings provided in the airplane. A cargo tie-down kit may also be installed. For further information on baggage and cargo tie-down, refer to Section 6. When loading the airplane, children should not be placed or permitted in the baggage compartment, and any material that might be hazardous to the airplane or occupants should not be placed anywhere in the airplane. For baggage area and door dimensions, refer to Section 6.

## SEATS

The seating arrangement consists of two individually adjustable four-way or six-way seats for the pilot and front seat passenger, and a split-backed fixed seat for the rear seat passengers. A child's seat (if installed) is located at the aft cabin bulkhead behind the rear seat.

The four-way seats may be moved forward or aft, and the seat back angle is infinitely adjustable. To position the seat, lift the tubular handle below the center of the seat frame, slide the seat into position, release the handle, and check that the seat is locked in place. The seat back is controlled by a cylinder lock release button which is spring-loaded to the locked position. The release button is located on the right side, below the forward corner of the seat cushion. To adjust the angle of the seat back, push up on the release button, position the seat back to the desired angle and release the button. When the seat is not occupied, the seat back will automatically fold forward whenever the release button is pushed up.

The six-way seats may be moved forward or aft, and are infinitely adjustable for height and seat back angle. To position the seat, lift the tubular handle under the center of the seat bottom, slide the seat into position, release the handle, and check that the seat is locked in place. Raise or lower the seat by rotating the large crank under the inboard corner of either seat. The seat back is adjusted by rotating the small crank under the outboard corner of either seat. The seat bottom angle will change as the seat back angle changes, providing proper support. The seat backs will also fold full forward.

The rear passengers' seat consists of a fixed one-piece seat bottom with individual infinitely adjustable seat backs. The seat back angle is controlled by cylinder lock release buttons which are spring-loaded to the locked position. The buttons are recessed into skirts located below the forward edge of the seat cushion near the outboard ends. To adjust the angle of a seat back, push up on the release button, position the seat back to the desired angle and release the button. When the seats are not occupied, the seat backs will automatically fold forward whenever the release buttons are pushed up.

A child's seat may be installed aft of the rear passengers' seat, and is held in place by two brackets mounted on the floorboard. The seat is designed to swing upward into a stowed position against the aft cabin bulkhead when not in use. To stow the seat, rotate the seat bottom up and aft as far as it will go. When not in use, the seat should be kept in the stowed position.

Headrests are available for any of the seat configurations except the child's seat. To adjust the headrest, apply enough pressure to it to raise or lower it to the desired level. The headrest may be removed at any time by raising it until it disengages from the top of the seat back.

## SEAT BELTS AND SHOULDER HARNESSSES

All seat positions are equipped with seat belts and all seats except the child's seat (if installed) have shoulder harnesses (see figure 7-4). Integrated seat belt/shoulder harnesses with inertia reels can be furnished for the pilot's and front passenger's seat positions, if desired.

### SEAT BELTS

The seat belts used with the pilot's and front passenger's seats, and the child's seat (if installed), are attached to fittings on the floorboard. The

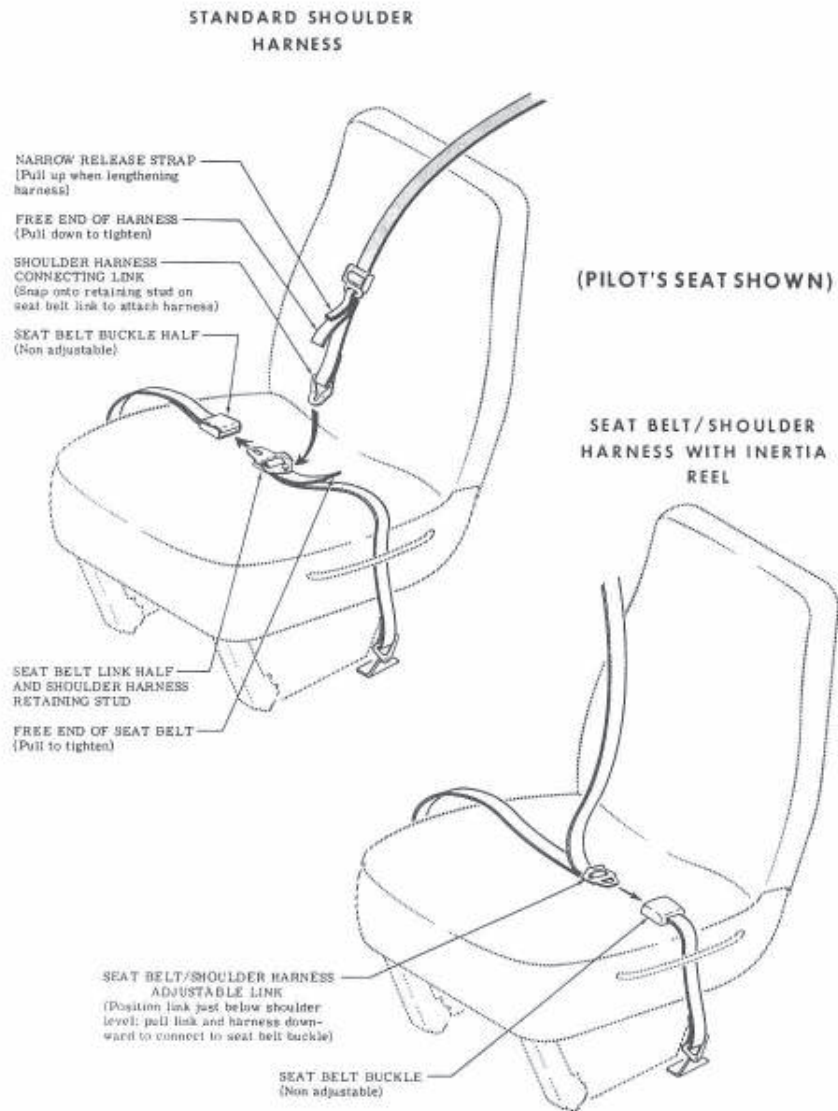

Figure 7-4. Seat Belts and Shoulder Harnesses

buckle half is inboard of each seat and the link half is outboard of each seat. The belts for the rear seat are attached to the seat frame, with the link halves on the left and right sides of the seat bottom, and the buckles at the center of the seat bottom.

To use the seat belts for the front seats, position the seat as desired, and then lengthen the link half of the belt as needed by grasping the sides of the link and pulling against the belt. Insert and lock the belt link into the buckle. Tighten the belt to a snug fit. Seat belts for the rear seat and the child's seat, are used in the same manner as the belts for the front seats. To release the seat belts, grasp the top of the buckle opposite the link and pull upward.

### SHOULDER HARNESSSES

Each front seat shoulder harness is attached to a rear doorpost above the window line and is stowed behind a stowage sheath above the cabin door. To stow the harness, fold it and place it behind the sheath. The rear seat shoulder harnesses are attached adjacent to the lower corners of the aft side windows. Each rear seat harness is stowed behind a stowage sheath above an aft side window. No harness is available for the child's seat.

To use a front or rear seat shoulder harness, fasten and adjust the seat belt first. Lengthen the harness as required by pulling on the connecting link on the end of the harness and the narrow release strap. Snap the connecting link firmly onto the retaining stud on the seat belt link half. Then adjust to length. A properly adjusted harness will permit the occupant to lean forward enough to sit completely erect, but prevent excessive forward movement and contact with objects during sudden deceleration. Also, the pilot will want the freedom to reach all controls easily.

Removing the shoulder harness is accomplished by pulling upward on the narrow release strap, and removing the harness connecting link from the stud on the seat belt link. In an emergency, the shoulder harness may be removed by releasing the seat belt first and allowing the harness, still attached to the link half of the seat belt, to drop to the side of the seat.

### INTEGRATED SEAT BELT/SHOULDER HARNESSSES WITH INERTIA REELS

Integrated seat belt/shoulder harnesses with inertia reels are available for the pilot and front seat passenger. The seat belt/shoulder harnesses extend from inertia reels located in the cabin top structure, through slots in the overhead console to attach points inboard of the two front seats. A separate seat belt half and buckle is located outboard of the seats. Inertia reels

allow complete freedom of body movement. However, in the event of a sudden deceleration, they will lock automatically to protect the occupants.

To use the seat belt/shoulder harness, position the adjustable metal link on the harness at about shoulder level, pull the link and harness downward, and insert the link in the seat belt buckle. Adjust belt tension across the lap by pulling upward on the shoulder harness. Removal is accomplished by releasing the seat belt buckle, which will allow the inertia reel to pull the harness inboard of the seat.

## ENTRANCE DOORS AND CABIN WINDOWS

Entry to, and exit from the airplane is accomplished through either of two entry doors, one on each side of the cabin at the front seat positions (refer to Section 6 for cabin and cabin door dimensions). The doors incorporate a recessed exterior door handle, a conventional interior door handle, a key-operated door lock (left door only), a door stop mechanism, and an openable window in the left door. An openable right door window is also available.

### NOTE

The door latch design on this model requires that the outside door handle on the pilot and front passenger doors be extended out whenever the doors are open. When closing the door, do not attempt to push the door handle in until the door is fully shut.

To open the doors from outside the airplane, utilize the recessed door handle near the aft edge of each door. Grasp the forward end of the handle and pull outboard. To close or open the doors from inside the airplane, use the combination door handle and arm rest. The inside door handle has three positions and a placard at its base which reads OPEN, CLOSE, and LOCK. The handle is spring-loaded to the CLOSE (up) position. When the door has been pulled shut and latched, lock it by rotating the door handle forward to the LOCK position (flush with the arm rest). When the handle is rotated to the LOCK position, an over-center action will hold it in that position. Both cabin doors should be locked prior to flight, and should not be opened intentionally during flight.

### NOTE

Accidental opening of a cabin door in flight due to improper closing does not constitute a need to land the airplane. The best procedure is to set up the airplane in a trimmed condition at approximately 80 KIAS, open a window, momentarily shove the door outward slightly, and forcefully close and lock the door.



Exit from the airplane is accomplished by rotating the door handle from the LOCK position, past the CLOSE position, aft to the OPEN position and pushing the door open. To lock the airplane, lock the right cabin door with the inside handle, close the left cabin door, and using the ignition key, lock the door.

The left cabin door is equipped with an openable window which is held in the closed position by a detent equipped latch on the lower edge of the window frame. To open the window, rotate the latch upward. The window is equipped with a spring-loaded retaining arm which will help rotate the window outward and hold it there. An openable window is also available for the right door, and functions in the same manner as the left window. If required, either window may be opened at any speed up to 179 KIAS. The cabin top windows (if installed), rear side windows, and rear window are of the fixed type and cannot be opened.

## CONTROL LOCKS

A control lock is provided to lock the aileron and elevator control surfaces to prevent damage to these systems by wind buffeting while the airplane is parked. The lock consists of a shaped steel rod and flag. The flag identifies the control lock and cautions about its removal before starting the engine. To install the control lock, align the hole in the top of the pilot's control wheel shaft with the hole in the top of the shaft collar on the instrument panel and insert the rod into the aligned holes. Installation of the lock will secure the ailerons in a neutral position and the elevators in a slightly trailing edge down position. Proper installation of the lock will place the flag over the ignition switch. In areas where high or gusty winds occur, a control surface lock should be installed over the vertical stabilizer and rudder. The control lock and any other type of locking device should be removed prior to starting the engine.

## ENGINE

The airplane is powered by a horizontally-opposed, six-cylinder, overhead-valve, air-cooled, carbureted engine with a wet sump lubrication system. The engine is a Continental Model O-470-U and is rated at 230 horsepower at 2400 RPM. Major accessories include a propeller governor on the front of the engine and dual magnetos, starter, belt-driven alternator, vacuum pump and full flow oil filter on the rear of the engine.

## ENGINE CONTROLS

Engine manifold pressure is controlled by a throttle located on the center area of the switch and control panel. The throttle operates in a

conventional manner; in the full forward position, the throttle is open, and in the full aft position, it is closed. A friction lock, which is a round knurled disk, is located at the base of the throttle and is operated by rotating the lock clockwise to increase friction or counterclockwise to decrease it.

The mixture control, mounted near the propeller control, is a red knob with raised points around the circumference and is equipped with a lock button in the end of the knob. The rich position is full forward, and full aft is the idle cut-off position. For small adjustments, the control may be moved forward by rotating the knob clockwise, and aft by rotating the knob counterclockwise. For rapid or large adjustments, the knob may be moved forward or aft by depressing the lock button in the end of the control, and then positioning the control as desired.

## ENGINE INSTRUMENTS

Engine operation is monitored by the following instruments: oil pressure gage, oil temperature gage, cylinder head temperature gage, tachometer, and manifold pressure gage. An economy mixture (EGT) indicator and carburetor air temperature gage are also available.

The oil pressure gage, located on the right side of the instrument panel, is operated by oil pressure. A direct pressure oil line from the engine delivers oil at engine operating pressure to the oil pressure gage. Gage markings indicate that minimum idling pressure is 10 PSI (red line), the normal operating range is 30 to 60 PSI (green arc), and maximum pressure is 100 PSI (red line).

Oil temperature is indicated by a gage adjacent to the oil pressure gage. The gage is operated by an electrical-resistance type temperature sensor which receives power from the airplane electrical system. Gage markings indicate the normal operating range (green arc) which is 100°F (38°C) to 240°F (116°C), and the maximum (red line) which is 240°F (116°C).

The cylinder head temperature gage, under the left fuel quantity indicator, is operated by an electrical-resistance type temperature sensor on the engine which receives power from the airplane electrical system. Gage markings indicate the normal operating range (green arc) which is 200°F (93°C) to 460°F (238°C) and the maximum (red line) which is 460°F (238°C).

The engine-driven mechanical tachometer is located on the lower right side of the instrument panel. The instrument is calibrated in increments of 100 RPM and indicates both engine and propeller speed. An hour meter below the center of the tachometer dial records elapsed engine time in hours and tenths. Instrument markings include a normal operating range

(green arc) of 2100 to 2400 RPM, and a maximum allowable (red line) of 2400 RPM.

The manifold pressure gage is located on the right side of the instrument panel above the tachometer. The gage is direct reading and indicates induction air manifold pressure in inches of mercury. It has a normal operating range (green arc) of 15 to 23 inches of mercury.

An economy mixture (EGT) indicator is available for the airplane and is located on the right side of the instrument panel. A thermocouple probe in the right exhaust stack assembly measures exhaust gas temperature and transmits it to the indicator. The indicator serves as a visual aid to the pilot in adjusting cruise mixture. Exhaust gas temperature varies with fuel-to-air ratio, power, and RPM. However, the difference between the peak EGT and the EGT at the cruise mixture setting is essentially constant and this provides a useful leaning aid. The indicator is equipped with a manually positioned reference pointer.

A carburetor air temperature gage is available for the airplane. Details of this gage are presented in Section 9, Supplements.

### NEW ENGINE BREAK-IN AND OPERATION

The engine underwent a run-in at the factory and is ready for the full range of use. It is, however, suggested that cruising be accomplished at 75% power as much as practicable until a total of 50 hours has accumulated or oil consumption has stabilized. This will ensure proper seating of the rings.

The airplane is delivered from the factory with corrosion preventive oil in the engine. If, during the first 25 hours, oil must be added, use only aviation grade straight mineral oil conforming to Specification No. MIL-L-6082.

### ENGINE LUBRICATION SYSTEM

The engine utilizes a full pressure, wet sump-type lubrication system with aviation grade oil used as the lubricant. Engine oil is also used for propeller and propeller governor operation. The capacity of the engine sump (located on the bottom of the engine) is 12 quarts (one additional quart is contained in the engine oil filter). Oil is drawn from the sump through a filter screen on the end of a pickup tube to the engine-driven oil pump. Oil from the pump passes through the full flow oil filter, a pressure relief valve at the rear of the right oil gallery, and a thermostatically controlled oil cooler. Oil from the cooler is then circulated to the left gallery and propeller governor. The engine parts are then lubricated by oil from the galleries. After lubricating the engine, the oil returns to the sump by gravity. The oil filter is equipped with a bypass valve which will cause lu-

bricating oil to bypass the filter in the event the filter becomes plugged, or the oil temperature is extremely cold.

An oil dipstick is located at the rear of the engine on the left side, and an oil filler tube is on top of the crankcase near the front of the engine. The dipstick and oil filler are accessible through doors on the engine cowling. The engine should not be operated on less than nine quarts of oil. To minimize loss of oil through the breather, fill to 10 quarts for normal flights of less than three hours. For extended flight, fill to 12 quarts (dipstick indication only). For engine oil grade and specifications, refer to Section 8 of this handbook.

The oil cooler may be replaced by a non-congealing oil cooler for operations in temperatures consistently below 20°F (-7°C). The non-congealing oil cooler provides improved oil flow at low temperatures. Once installed, the non-congealing oil cooler is approved for permanent use in both hot and cold weather.

An oil quick-drain valve is available to replace the drain plug on the bottom of the oil sump, and provides quicker, cleaner draining of the engine oil. To drain the oil with this valve installed, slip a hose over the end of the valve and push upward on the end of the valve until it snaps into the open position. Spring clips will hold the valve open. After draining, use a suitable tool to snap the valve into the extended (closed) position and remove the drain hose.

### IGNITION-STARTER SYSTEM

Engine ignition is provided by two engine-driven magnetos, and two spark plugs in each cylinder. The right magneto fires the lower left and upper right spark plugs, and the left magneto fires the lower right and upper left spark plugs. Normal operation is conducted with both magnetos due to the more complete burning of the fuel-air mixture with dual ignition.

Ignition and starter operation is controlled by a rotary type switch located on the left switch and control panel. The switch is labeled clockwise, OFF, R, L, BOTH, and START. The engine should be operated on both magnetos (BOTH position) except for magneto checks. The R and L positions are for checking purposes and emergency use only. When the switch is rotated to the spring-loaded START position, (with the master switch in the ON position), the starter contactor is energized and the starter will crank the engine. When the switch is released, it will automatically return to the BOTH position.

### AIR INDUCTION SYSTEM

The engine air induction system receives ram air through an intake in

the lower front portion of the engine cowling. The intake is covered by an air filter which removes dust and other foreign matter from the induction air. Airflow passing through the filter enters an airbox. After passing through the airbox, induction air enters the inlet in the carburetor which is under the engine, and is then ducted to the engine cylinders through intake manifold tubes. In the event carburetor ice is encountered or the intake filter becomes blocked, alternate heated air can be obtained from a shroud around an exhaust riser through a duct to a valve, in the airbox, operated by the carburetor heat control on the instrument panel. Heated air from the exhaust riser shroud is obtained from unfiltered air inside the cowling. Use of full carburetor heat at full throttle will result in a loss of approximately one to two inches of manifold pressure.

### EXHAUST SYSTEM

Exhaust gas from each cylinder passes through riser assemblies to a muffler and tailpipe. The muffler is constructed with a shroud around the outside which forms a heating chamber for cabin heater air.

### CARBURETOR AND PRIMING SYSTEM

The engine is equipped with an up-draft, float-type, fixed jet carburetor mounted on the bottom of the engine. The carburetor is equipped with an enclosed accelerator pump, an idle cut-off mechanism, and a manual mixture control. Fuel is delivered to the carburetor by gravity flow from the fuel system. In the carburetor, fuel is atomized, proportionally mixed with intake air, and delivered to the cylinders through intake manifold tubes. The proportion of atomized fuel to air may be controlled, within limits, by the mixture control on the instrument panel.

To facilitate starting in cold weather, the engine is equipped with a manual primer. The primer is actually a small pump which draws fuel from the fuel strainer when the plunger is pulled out, and injects it into the intake manifold when the plunger is pushed back in. The plunger is equipped with a lock and, after being pushed full in, must be rotated either left or right until the knob cannot be pulled out. A six-port primer is available which injects the fuel into individual cylinder intake ports in lieu of the intake manifold. Both primers are identical in appearance, except for the plumbing, and operate in the same manner.

### COOLING SYSTEM

Ram air for engine cooling enters through two intake openings in the front of the engine cowling. The cooling air is directed around the cylinders and other areas of the engine by baffling, and is then exhausted through cowl flaps on the lower aft edge of the cowling. The cowl flaps are mechanically operated from the cabin by means of a cowl flap lever on the

right side of the control pedestal. The pedestal is labeled OPEN, COWL FLAPS, CLOSED. Before starting the engine, takeoff and high power operation, the cowl flap lever should be placed in the OPEN position for maximum cooling. This is accomplished by moving the lever to the right to clear a detent, then moving the lever up to the OPEN position. Anytime the lever is repositioned, it must first be moved to the right. While in cruise flight, cowl flaps should be adjusted to keep the cylinder head temperature at approximately two-thirds of the normal operating range (green arc). During extended let-downs, it may be necessary to completely close the cowl flaps by pushing the cowl flap lever down to the CLOSED position.

A winterization kit is available for the airplane. Details of this kit are presented in Section 9, Supplements.

## PROPELLER

The airplane has an all-metal, two-bladed, constant-speed, governor-regulated propeller. A setting introduced into the governor with the propeller control establishes the propeller speed, and thus the engine speed to be maintained. The governor then controls flow of engine oil, boosted to high pressure by the governing pump, to or from a piston in the propeller hub. Oil pressure acting on the piston twists the blades toward high pitch (low RPM). When oil pressure to the piston in the propeller hub is relieved, centrifugal force, assisted by an internal spring, twists the blades toward low pitch (high RPM).

A control knob on the center area of the switch and control panel is used to set the propeller and control engine RPM as desired for various flight conditions. The knob is labeled PROP PITCH, PUSH INCR RPM. When the control knob is pushed in, blade pitch will decrease, giving a higher RPM. When the control knob is pulled out, the blade pitch increases, thereby decreasing RPM. The propeller control knob is equipped with a vernier feature which allows slow or fine RPM adjustments by rotating the knob clockwise to increase RPM, and counterclockwise to decrease it. To make rapid or large adjustments, depress the button on the end of the control knob and reposition the control as desired.

## FUEL SYSTEM

The airplane fuel system (see figure 7-5) consists of two vented integral fuel tanks (one in each wing), a four-position selector valve, fuel strainer, manual primer and carburetor. Refer to figure 7-6 for fuel quantity data for the system.

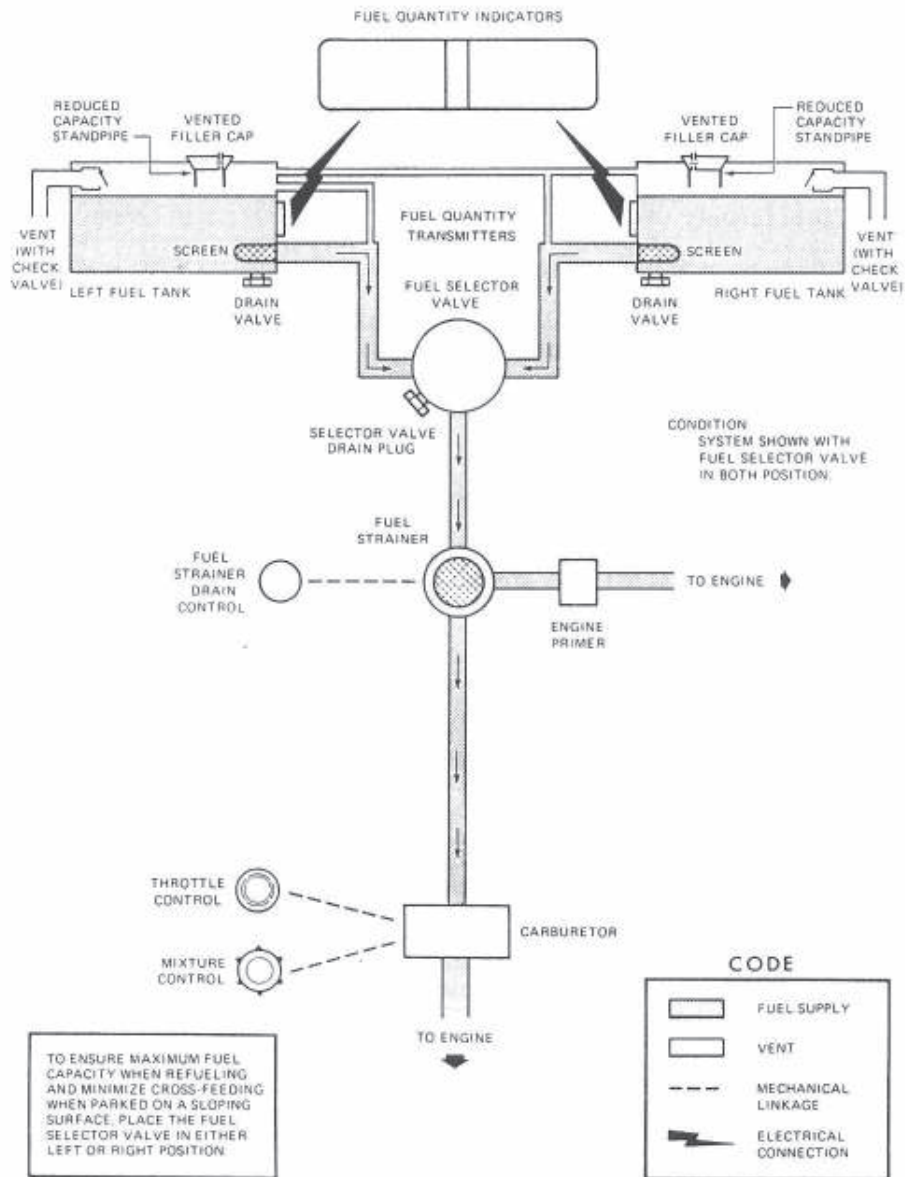

Figure 7-5. Fuel System

Fuel flows by gravity from the two integral wing tanks to a four-position selector valve, labeled BOTH, RIGHT, LEFT, and OFF. The selector handle must be pushed down before it can be rotated from RIGHT or LEFT to OFF. With the selector valve in either the BOTH, RIGHT, or LEFT position, fuel flows through a strainer to the carburetor. From the carburetor, mixed fuel and air flows to the cylinders through intake manifold tubes. The manual primer draws its fuel from the fuel strainer and injects it into the intake manifold.

The airplane may be serviced to a reduced capacity to permit heavier cabin loadings. This is accomplished by filling each tank to the bottom edge of the fuel filler neck, thus giving a reduced fuel load of 34.5 gallons in each tank (32.5 gallons usable in all flight conditions).

Fuel system venting is essential to system operation. Complete blockage of the venting system will result in a decreasing fuel flow and eventual engine stoppage. Venting consists of an interconnecting vent line between the tanks, and check valve equipped overboard vents in each tank. The overboard vents protrude from the bottom surfaces of the wings behind the wing struts, slightly below the upper attach points of the struts. The fuel filler caps are vacuum vented; the vents will open and allow air to enter the fuel tanks in case the overboard vents become blocked.

Fuel quantity is measured by two float-type fuel quantity transmitters (one in each fuel tank) and indicated by two electrically-operated fuel quantity indicators on the right side of the instrument panel. The fuel quantity indicators are calibrated in gallons (lower scale) and pounds (upper scale). An empty tank is indicated by a red line and the letter E. When an indicator shows an empty tank, approximately 2.0 gallons remain in a tank as unusable fuel. The indicators cannot be relied upon for accurate readings during skids, slips, or unusual flight attitudes. If both

FUEL QUANTITY DATA (U.S. GALLONS)				
FUEL TANKS	FUEL LEVEL (QUANTITY EACH TANK)	TOTAL FUEL	TOTAL UNUSABLE	TOTAL USABLE ALL FLIGHT CONDITIONS
STANDARD	FULL (46)	92	4	88
	REDUCED (34.5)	69	4	65

Figure 7-6. Fuel Quantity Data



indicator pointers should rapidly move to a zero reading, check the cylinder head temperature and oil temperature gages for operation. If these gages are not indicating, an electrical malfunction has occurred.

The fuel selector valve should be in the BOTH position for takeoff, climb, descent, landing, and maneuvers that involve prolonged slips or skids. Operation from either LEFT or RIGHT tank is reserved for level cruising flight only.

**NOTE**

Unusable fuel is at a minimum due to the design of the fuel system. However, with 1/4 tank or less, prolonged uncoordinated flight such as slips or skids can uncover the fuel tank outlets, causing fuel starvation and engine stoppage. Therefore, with low fuel reserves, do not allow the airplane to remain in uncoordinated flight for periods in excess of one minute.

**NOTE**

When the fuel selector valve handle is in the BOTH position in cruising flight, unequal fuel flow from each tank may occur if the wings are not maintained exactly level. Resulting wing heaviness can be alleviated gradually by turning the selector valve handle to the tank in the "heavy" wing.

**NOTE**

It is not practical to measure the time required to consume all of the fuel in one tank, and, after switching to the opposite tank, expect an equal duration from the remaining fuel. The airspace in both fuel tanks is interconnected by a vent line and, therefore, some sloshing of fuel between tanks can be expected when the tanks are nearly full and the wings are not level.

If a fuel tank quantity is completely exhausted in flight, it is recommended that the fuel selector valve be switched back to the BOTH position for the remainder of the flight. This will allow some fuel from the fuller tank to transfer back through the selector valve to the empty tank while in coordinated flight which in turn will assure optimum fuel feed during slipping or skidding flight.

The fuel system is equipped with drain valves to provide a means for the examination of fuel in the system for contamination and grade. The system should be examined before the first flight of every day and after

each refueling, by using the sampler cup provided to drain fuel from the wing tank sumps, and by utilizing the fuel strainer drain under an access panel on the left side of the engine cowling. If any evidence of fuel contamination is found, it must be eliminated in accordance with the Preflight Inspection checklist and the discussion in Section 8 of this handbook. The fuel tanks should be filled after each flight to prevent condensation.

## BRAKE SYSTEM

The airplane has a single-disc, hydraulically-actuated brake on each main landing gear wheel. Each brake is connected, by a hydraulic line, to a master cylinder attached to each of the pilot's rudder pedals. The brakes are operated by applying pressure to the top of either the left (pilot's) or right (copilot's) set of rudder pedals, which are interconnected. When the airplane is parked, both main wheel brakes may be set by utilizing the parking brake which is operated by a handle below the left side of the switch and control panel. To apply the parking brake, set the brakes with the rudder pedals, pull the handle aft, and rotate it 90° down.

For maximum brake life, keep the brake system properly maintained, and minimize brake usage during taxi operations and landings.

Some of the symptoms of impending brake failure are: gradual decrease in braking action after brake application, noisy or dragging brakes, soft or spongy pedals, and excessive travel and weak braking action. If any of these symptoms appear, the brake system is in need of immediate attention. If, during taxi or landing roll, braking action decreases, let up on the pedals and then re-apply the brakes with heavy pressure. If the brakes become spongy or pedal travel increases, pumping the pedals should build braking pressure. If one brake becomes weak or fails, use the other brake sparingly while using opposite rudder, as required, to offset the good brake.

## ELECTRICAL SYSTEM

The airplane is equipped with a 28-volt, direct-current electrical system (see figure 7-7). The system is powered by a belt-driven, 60-amp alternator and a 24-volt battery (a heavy duty battery is available) located in the tailcone aft of the baggage compartment wall. Power is supplied to most general electrical and all avionics circuits through the primary bus bar and the avionics bus bar, which are interconnected by an avionics power switch. The primary bus is on anytime the master switch is turned on, and is not affected by starter or external power usage. Both bus bars are on anytime the master switch and avionics power switches are turned on.

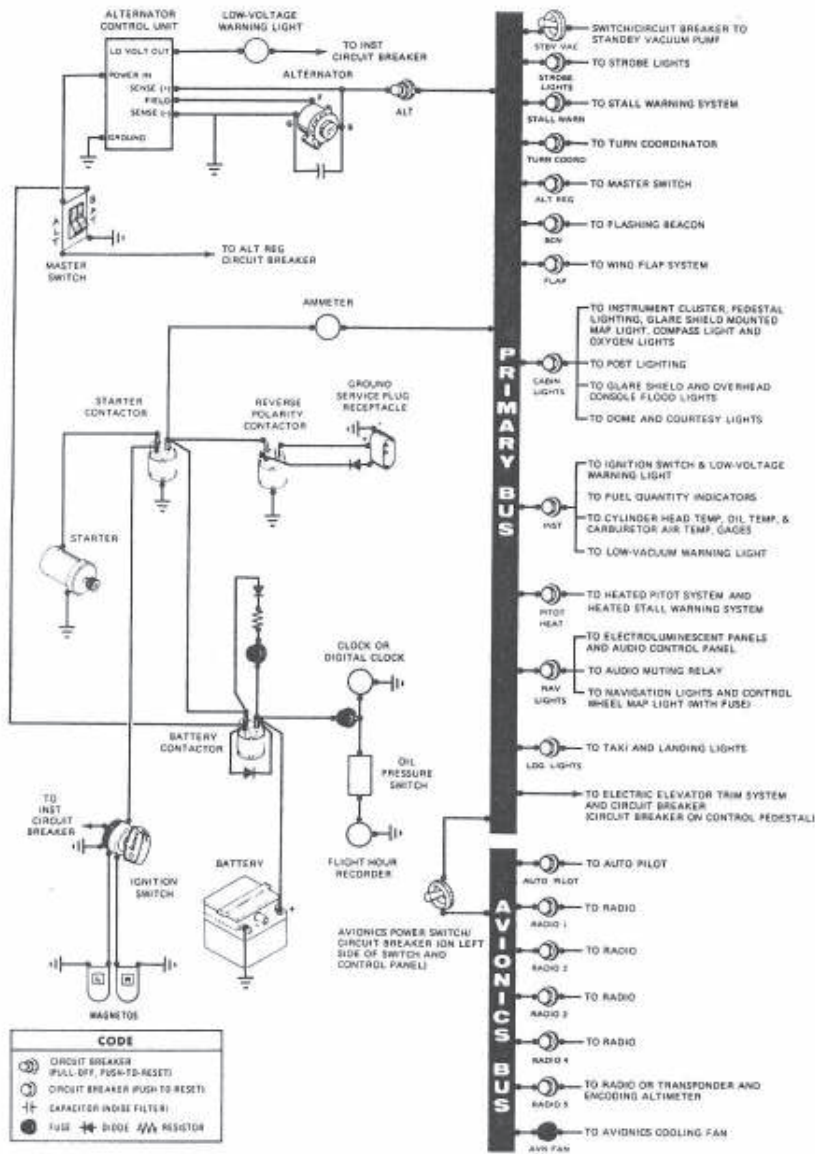

Figure 7-7. Electrical System

**CAUTION**

Prior to turning the master switch on or off, starting the engine, or applying an external power source, the avionics power switch, labeled AVIONICS POWER, should be turned off to prevent any harmful transient voltage from damaging the avionics equipment.

**MASTER SWITCH**

The master switch is a split-rocker type switch labeled MASTER, and is ON in the up position and off in the down position. The right half of the switch, labeled BAT, controls all electrical power to the airplane. The left half, labeled ALT, controls the alternator.

Normally, both sides of the master switch should be used simultaneously; however, the BAT side of the switch could be turned ON separately to check equipment while on the ground. To check or use avionics equipment or radios while on the ground, the avionics power switch must be turned ON. The ALT side of the switch, when placed in the off position, removes the alternator from the electrical system. With this switch in the off position, the entire electrical load is placed on the battery. Continued operation with the alternator switch in the off position will reduce battery power low enough to open the battery contactor, remove power from the alternator field, and prevent alternator restart.

**AVIONICS POWER SWITCH**

Electrical power from the airplane primary bus to the avionics bus (see figure 7-7) is controlled by a toggle switch/circuit breaker labeled AVIONICS POWER. The switch is located on the left side of the switch and control panel and is ON in the up position and off in the down position. With the switch in the off position, no electrical power will be applied to the avionics equipment, regardless of the position of the master switch or the individual equipment switches. The avionics power switch also functions as a circuit breaker. If an electrical malfunction should occur and cause the circuit breaker to open, electrical power to the avionics equipment (including the avionics cooling fan) will be interrupted and the switch will automatically move to the off position. If this occurs, allow the circuit breaker to cool approximately two minutes before placing the switch in the ON position again. If the circuit breaker opens again, do not reset it. The avionics power switch should be placed in the off position prior to turning the master switch ON or off, starting the engine, or applying an external power source, and may be utilized in place of the individual avionics equipment switches.

**AMMETER**

The ammeter, located between the fuel gages, indicates the amount of

current, in amperes, from the alternator to the battery or from the battery to the airplane electrical system. When the engine is operating and the master switch is turned on, the ammeter indicates the charging rate applied to the battery. In the event the alternator is not functioning or the electrical load exceeds the output of the alternator, the ammeter indicates the battery discharge rate.

#### **ALTERNATOR CONTROL UNIT AND LOW-VOLTAGE WARNING LIGHT**

The airplane is equipped with a combination alternator regulator high-low voltage control unit mounted on the engine side of the firewall and a red warning light, labeled **LOW VOLTAGE**, on the left side of the instrument panel adjacent to the airspeed indicator.

In the event an over-voltage condition occurs, the alternator control unit automatically removes alternator field current which shuts down the alternator. The battery will then supply system current as shown by a discharge rate on the ammeter. Under these conditions, depending on electrical system load, the low-voltage warning light will illuminate when system voltage drops below normal. The alternator control unit may be reset by turning the master switch off and back on again. If the warning light does not illuminate, normal alternator charging has resumed; however, if the light does illuminate again, a malfunction has occurred, and the flight should be terminated as soon as practicable.

#### **NOTE**

Illumination of the low-voltage light and ammeter discharge indications may occur during low RPM conditions with an electrical load on the system, such as during a low RPM taxi. Under these conditions, the light will go out at higher RPM. The master switch need not be recycled since an over-voltage condition has not occurred to de-activate the alternator system.

The warning light may be tested by turning on the landing lights and momentarily turning off the **ALT** portion of the master switch while leaving the **BAT** portion turned on.

#### **CIRCUIT BREAKERS AND FUSES**

Most of the electrical circuits in the airplane are protected by "push-to-reset" type circuit breakers mounted on the left side of the switch and control panel. However, circuit breakers protecting the alternator output and the electric elevator trim circuits are the "pull-off" type. In addition to the individual circuit breakers, a toggle switch/circuit breaker, labeled **AV-**

IONICS POWER, on the left switch and control panel also protects the avionics systems. The control wheel map light (if installed) is protected by the NAV LIGHTS circuit breaker and a fuse behind the instrument panel. Electrical circuits which are not protected by circuit breakers are the battery contactor closing (external power) circuit, clock circuit, and flight hour recorder circuit. These circuits are protected by fuses mounted adjacent to the battery. Also, a fuse, located on the left switch and control panel, protects the avionics cooling fan circuit.

Spare fuses are required to be carried in the airplane at all times. To assist the pilot in meeting this requirement, a special spare fuse holder is located inside the cover of the Pilot's Operating Handbook. This holder contains an assortment of spare fuses to be used in the event an installed fuse requires replacement. If one of the fuses from the holder is used, a replacement spare should be obtained for the fuse holder.

### GROUND SERVICE PLUG RECEPTACLE

A ground service plug receptacle may be installed to permit the use of an external power source for cold weather starting and during lengthy maintenance work on the electrical and electronic equipment. Details of the ground service plug receptacle are presented in Section 9, Supplements.

## LIGHTING SYSTEMS

### EXTERIOR LIGHTING

Conventional navigation lights are located on the wing tips and tail stinger, and dual landing/taxi lights are installed in the cowl nose cap. Additional lighting is available and includes a strobe light on each wing tip, a flashing beacon on top of the vertical stabilizer, and two courtesy lights, one under each wing, just outboard of the cabin doors. Details of the strobe light system are presented in Section 9, Supplements. The courtesy lights are operated by a switch located on the left rear door post. All exterior lights, except the courtesy lights, are operated by rocker switches on the left switch and control panel. The switches are ON in the up position and off in the down position.

The flashing beacon should not be used when flying through clouds or overcast; the flashing light reflected from water droplets or particles in the atmosphere, particularly at night, can produce vertigo and loss of orientation.

### INTERIOR LIGHTING

Instrument and control panel lighting is provided by flood and integral

lighting, with electroluminescent and post lighting also available. Dual concentric light dimming rheostats on the left side of the switch and control panel control the intensity of all lighting. The following paragraphs describe the various lighting systems and their controls.

The left and right sides of the switch and control panel, and the audio control panel may be lighted by electroluminescent panels which do not require light bulbs for illumination. To utilize this lighting, turn the NAV light rocker switch to the ON position and rotate the inner knob labeled EL PANEL, on the right dimming rheostat, clockwise to the desired light intensity.

Instrument panel flood lighting consists of four red lights on the underside of the glare shield, and two red flood lights in the forward section of the overhead console. This lighting is controlled by rotating the outer knob labeled FLOOD, on the left dimming rheostat, clockwise to the desired intensity.

The instrument panel may be equipped with post lights which are mounted at the edge of each instrument or control and provide direct lighting. This lighting is controlled by rotating the inner knob labeled POST, on the left dimming rheostat, clockwise to the desired light intensity. Flood and post lights may be used simultaneously by rotating both the FLOOD and POST knobs clockwise to the desired intensity for each type of lighting.

The engine instrument cluster, radio equipment, and magnetic compass have integral lighting and operate independently of post or flood lighting. To operate these lights, rotate the outer knob labeled ENG-RADIO, on the right dimming rheostat, clockwise to the desired light intensity. However, for daylight operation, the compass and engine instrument lights may be turned off while still maintaining maximum light intensity for the digital readouts in the radio equipment. This is accomplished by rotating the ENG-RADIO knob full counterclockwise. Check that the flood lights, post lights, and electroluminescent lights are turned off for daylight operation by rotating the FLOOD, POST, and EL PANEL knobs full counterclockwise.

The control pedestal has two integral lights and, if the airplane is equipped with oxygen, the overhead console is illuminated by post lights. Pedestal and console light intensity is controlled by the knob labeled ENG-RADIO, on the right dimming rheostat.

Map lighting is provided by overhead console map lights and a glare shield mounted map light. The airplane may also be equipped with a control wheel map light. The overhead console map lights operate in conjunction with instrument panel flood lighting and consist of two

openings just aft of the red instrument panel flood lights. The map light openings have sliding covers controlled by small round knobs which uncover the openings when moved toward each other. The covers should be kept closed unless the map lights are required. A map light and toggle switch, mounted in front of the pilot on the underside of the glare shield, is used for illuminating approach plates or other charts when using a control wheel mounted approach plate holder. The switch is labeled MAP LIGHT, ON, OFF and light intensity is controlled by the knob labeled FLOOD, on the left dimming rheostat. The pilot's control wheel map light (if installed) illuminates the lower portion of the cabin in front of the pilot, and is used for checking maps and other flight data during night operation. The light is utilized by turning the NAV light switch to the ON position and adjusting light intensity with the rheostat control knob on the bottom of the control wheel.

The airplane is equipped with a dome light aft of the overhead console. The light is operated by a slide-type switch, aft of the light lens, which turns the light on when moved to the right.

The most probable cause of a light failure is a burned out bulb; however, in the event any of the lighting systems fail to illuminate when turned on, check the appropriate circuit breaker. If the circuit breaker has opened (white button popped out), and there is no obvious indication of a short circuit (smoke or odor), turn off the light switch of the affected lights, reset the breaker, and turn the switch on again. If the breaker opens again, do not reset it.

## CABIN HEATING, VENTILATING AND DEFROSTING SYSTEM

The temperature and volume of airflow into the cabin can be regulated by manipulation of the push-pull CABIN HEAT and CABIN AIR control knobs (see figure 7-8). Both control knobs are the double button type with locks to permit intermediate settings.

### NOTE

For improved partial heating on mild days, pull out the CABIN AIR knob slightly when the CABIN HEAT knob is out. This action increases the airflow through the system, increasing efficiency, and blends cool outside air with the exhaust manifold heated air, thus eliminating the possibility of overheating the system ducting.

Front cabin heat and ventilating air is supplied by outlet holes spaced across a cabin manifold just forward of the pilot's and copilot's feet. Rear cabin heat and air is supplied by two ducts from the manifold, one



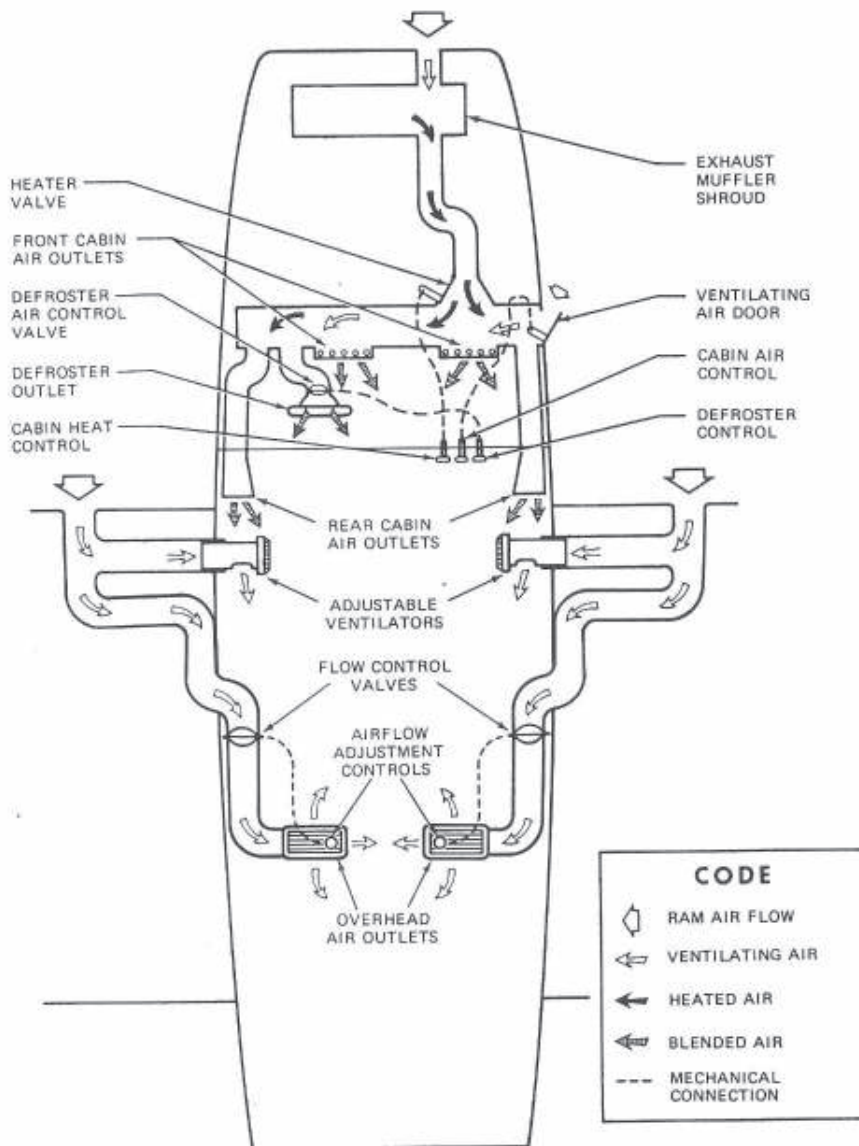

Figure 7-8. Cabin Heating, Ventilating, and Defrosting System

extending down each side of the cabin to an outlet at the front door post at floor level. Windshield defrost air is also supplied by a duct leading from the cabin manifold to an outlet on top of the anti-glare shield. Defrost air flow is controlled by a rotary type knob labeled DEFROST.

For cabin ventilation, pull the CABIN AIR knob out, with the CABIN HEAT knob pushed full in. To raise the air temperature, pull the CABIN HEAT knob out until the desired temperature is attained. Additional heat is available by pulling the knob out farther; maximum heat is available with the CABIN HEAT knob pulled out and the CABIN AIR knob pushed full in.

Separate adjustable ventilators supply additional ventilation air to the cabin. One near each upper corner of the windshield supplies air for the pilot and copilot, and two ventilators are available for the rear cabin area to supply air to the rear seat passengers. Each rear ventilator outlet can be adjusted in any desired direction by moving the entire outlet to direct the airflow forward and aft and by moving a wheel protruding from the center of the outlet left or right to obtain left or right airflow. Ventilation airflow may be closed off completely, or partially closed according to the amount of airflow desired, by rotating a control knob adjacent to the outlet.

## PITOT-STATIC SYSTEM AND INSTRUMENTS

The pitot-static system supplies ram air pressure to the airspeed indicator and static pressure to the airspeed indicator, vertical speed indicator and altimeter. The system is composed of either an unheated or heated pitot tube mounted on the lower surface of the left wing, two external static ports on the lower left and right sides of the forward fuselage, and the associated plumbing necessary to connect the instruments to the sources.

The heated pitot system (if installed) consists of a heating element in the pitot tube, a rocker switch labeled PITOT HEAT and a 10-amp push-to-reset circuit breaker on the left side of the switch and control panel, and associated wiring. When the pitot heat switch is turned on, the element in the pitot tube is heated electrically to maintain proper operation in possible icing conditions. Pitot heat should be used only as required.

A static pressure alternate source valve may be installed adjacent to the parking brake, and can be used if the external static source is malfunctioning. This valve supplies static pressure from inside the cabin instead of the external static ports.

If erroneous instrument readings are suspected due to water or ice in the pressure line going to the standard external static pressure source, the

alternate static source valve should be pulled on.

Pressures within the cabin will vary with heater/vents opened or closed, and windows open. Refer to Sections 3 and 5 for the effect of varying cabin pressures on airspeed and altimeter readings.

### AIRSPEED INDICATOR

The airspeed indicator is calibrated in knots and miles per hour. Limitation and range markings (in KIAS) include the white arc (40 to 95 knots), green arc (50 to 143 knots), yellow arc (143 to 179 knots), and a red line (179 knots).

If a true airspeed indicator is installed, it is equipped with a rotatable ring which works in conjunction with the airspeed indicator dial in a manner similar to the operation of a flight computer. To operate the indicator, first rotate the ring until pressure altitude is aligned with outside air temperature in degrees Fahrenheit. Pressure altitude should not be confused with indicated altitude. To obtain pressure altitude, momentarily set the barometric scale on the altimeter to 29.92 and read pressure altitude on the altimeter. Be sure to return the altimeter barometric scale to the original barometric setting after pressure altitude has been obtained. Having set the ring to correct for altitude and temperature, read the true airspeed shown on the rotatable ring by the indicator pointer. For best accuracy, the indicated airspeed should be corrected to calibrated airspeed by referring to the Airspeed Calibration chart in Section 5. Knowing the calibrated airspeed, read true airspeed on the ring opposite the calibrated airspeed.

### VERTICAL SPEED INDICATOR

The vertical speed indicator depicts airplane rate of climb or descent in feet per minute. The pointer is actuated by atmospheric pressure changes resulting from changes of altitude as supplied by the static source.

### ALTIMETER

Airplane altitude is depicted by a barometric type altimeter. A knob near the lower left portion of the indicator provides adjustment of the instrument's barometric scale to the current altimeter setting.

## VACUUM SYSTEM AND INSTRUMENTS

An engine-driven vacuum system (see figure 7-9) provides the suction necessary to operate the attitude indicator and directional indicator. The system consists of a vacuum pump mounted on the engine, a vacuum relief

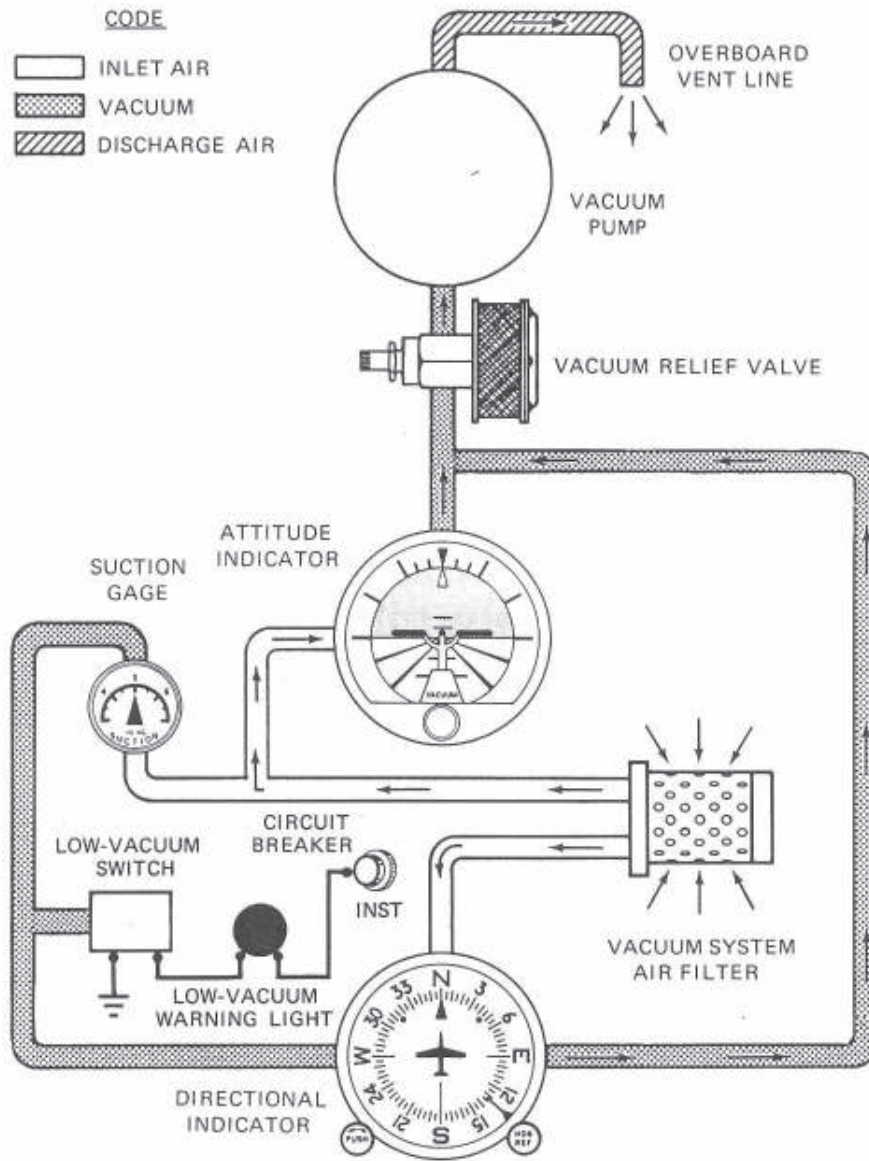

Figure 7-9. Vacuum System

valve and vacuum system air filter on the aft side of the firewall below the instrument panel, and instruments (including a suction gage and a low-vacuum warning light) on the left side of the instrument panel. An optional electrically-driven standby vacuum pump may also be installed. It is designed to provide adequate vacuum in the event of failure of the engine-driven pump. Details of this system are presented in Section 9, Supplements.

### ATTITUDE INDICATOR

The attitude indicator gives a visual indication of flight attitude. Bank attitude is presented by a pointer at the top of the indicator relative to the bank scale which has index marks at 10°, 20°, 30°, 60°, and 90° either side of the center mark. Pitch and roll attitudes are presented by a miniature airplane superimposed over a symbolic horizon area divided into two sections by a white horizon bar. The upper "blue sky" area and the lower "ground" area have arbitrary pitch reference lines useful for pitch attitude control. A knob at the bottom of the instrument is provided for inflight adjustment of the miniature airplane to the horizon bar for a more accurate flight attitude indication.

### DIRECTIONAL INDICATOR

The directional indicator displays airplane heading on a compass card in relation to a fixed simulated airplane image and index. The directional indicator will precess slightly over a period of time. Therefore, the compass card should be set in accordance with the magnetic compass just prior to takeoff, and occasionally re-adjusted on extended flights. A knob on the lower left edge of the instrument is used to adjust the compass card to correct for any precession.

### SUCTION GAGE

The suction gage, located on the left side of the instrument panel, is calibrated in inches of mercury and indicates suction available for operation of the attitude and directional indicators. The desired suction range is 4.5 to 5.4 inches of mercury. Normally, a suction reading out of this range may indicate a system malfunction or improper adjustment, and in this case, the indicators should not be considered reliable. However, due to lower atmospheric pressures at higher altitudes, the suction gage may indicate as low as 4.0 in. Hg. at 20,000 feet and still be adequate for normal system operation.

### LOW-VACUUM WARNING LIGHT

A red low-vacuum warning light is installed on the left side of instrument panel to warn the pilot of a possible low-vacuum condition existing

in the vacuum system. Illumination of the light warns the pilot to check the suction gage and to be alert for possible erroneous vacuum-driven gyro instrument indications.

## OUTSIDE AIR TEMPERATURE (OAT) GAGE

An outside air temperature (OAT) gage is installed in the right wing root ventilator. The gage is calibrated in degrees Fahrenheit and Centigrade. For best indicator accuracy, air should be flowing through the ventilator across the probe.

## STALL WARNING SYSTEM

The airplane is equipped with a vane-type stall warning unit, in the leading edge of the left wing, which is electrically connected to a stall warning horn located in the headliner above the left cabin door. A 5-amp push-to-reset circuit breaker labeled STALL WARN, on the left side of the switch and control panel, protects the stall warning system. The vane in the wing senses the change in airflow over the wing, and operates the warning horn at airspeeds between 5 and 10 knots above the stall in all configurations.

If the airplane has a heated stall warning system, the vane and sensor unit in the wing leading edge is equipped with a heating element. The heated part of the system is operated by the PITOT HEAT switch, and is protected by the PITOT HEAT circuit breaker.

The stall warning system should be checked during the pre-flight inspection by momentarily turning on the master switch and actuating the vane in the wing. The system is operational if the warning horn sounds as the vane is pushed upward.

## AVIONICS SUPPORT EQUIPMENT

If the airplane is equipped with avionics, various avionics support equipment may also be installed. Equipment available includes an avionics cooling fan, microphone-headset installations and control surface static dischargers. The following paragraphs discuss these items. Description and operation of radio equipment is covered in Section 9 of this handbook.

### AVIONICS COOLING FAN

An avionics cooling fan system is provided whenever a factory-installed Nav/Com radio is installed. The system is designed to provide internal cooling air from a small electric fan to the avionics units and thereby eliminate the possibility of moisture contamination using an

external cooling air source.

Power to the electric fan is supplied directly from the avionics bus through a fuse labeled, AVN FAN, located on the left switch and control panel. Hence, power is supplied to the fan anytime the master and avionics power switches are ON.

## MICROPHONE-HEADSET INSTALLATIONS

Three types of microphone-headset installations are offered. The standard system provided with avionics equipment includes a hand-held microphone and separate headset. The keying switch for this microphone is on the microphone. Two optional microphone-headset installations are also available; these feature a single-unit microphone-headset combination which permits the pilot or front passenger to conduct radio communications without interrupting other control operations to handle a hand-held microphone. One microphone-headset combination is a lightweight type without a padded headset and the other version has a padded headset. The microphone-headset combinations utilize a remote keying switch located on the left grip of the pilot's control wheel and, if an optional intercom system is installed, a second switch on the right grip of the front passenger's control wheel. The microphone and headset jacks are located on the lower left and right sides of the instrument panel. Audio to all three headsets is controlled by the individual audio selector switches and adjusted for volume level by using the selected receiver volume controls.

### NOTE

To ensure audibility and clarity when transmitting with the hand-held microphone, always hold it as closely as possible to the lips, then key the microphone and speak directly into it. Avoid covering opening on back side of microphone for optimum noise canceling.

## STATIC DISCHARGERS

If frequent IFR flights are planned, installation of wick-type static dischargers is recommended to improve radio communications during flight through dust or various forms of precipitation (rain, snow or ice crystals). Under these conditions, the build-up and discharge of static electricity from the trailing edges of the wings, rudder, elevator, propeller tips, and radio antennas can result in loss of usable radio signals on all communications and navigation radio equipment. Usually the ADF is first to be affected and VHF communication equipment is the last to be affected.

Installation of static dischargers reduces interference from precipitation static, but it is possible to encounter severe precipitation static conditions which might cause the loss of radio signals, even with static

dischargers installed. Whenever possible, avoid known severe precipitation areas to prevent loss of dependable radio signals. If avoidance is impractical, minimize airspeed and anticipate temporary loss of radio signals while in these areas.

Static dischargers lose their effectiveness with age, and therefore, should be checked periodically (at least at every annual inspection) by qualified avionics technicians, etc. If testing equipment is not available, it is recommended that the wicks be replaced every two years, especially if the airplane is operated frequently in IFR conditions. The discharger wicks are designed to unscrew from their mounting bases to facilitate replacement.

## CABIN FEATURES

### CABIN FIRE EXTINGUISHER

A portable Halon 1211 (Bromochlorodifluoromethane) fire extinguisher is available for installation on the pilot's seat where it would be accessible in case of fire. The extinguisher has an Underwriters Laboratories classification of 5B:C. If installed, the extinguisher should be checked prior to each flight to ensure that its bottle pressure, as indicated by the gage on the bottle, is within the green arc (approximately 125 psi) and the operating lever lock pin is securely in place.

To operate the fire extinguisher:

1. Loosen retaining clamp(s) and remove extinguisher from bracket.
2. Hold extinguisher upright, pull operating lever lock pin, and press lever while directing the discharge at the base of the fire at the near edge. Progress toward the back of the fire by moving the nozzle rapidly with a side-to-side sweeping motion.

#### CAUTION

Care must be taken not to direct the initial discharge directly at the burning surface at close range (less than five feet) because the high velocity stream may cause splashing and/or scattering of the burning material.

3. Anticipate approximately eight seconds of discharge duration.

#### WARNING

Ventilate the cabin promptly after successfully extinguish-



ing the fire to reduce the gases produced by thermal decomposition.

Fire extinguishers should be recharged by a qualified fire extinguisher agency after each use. Such agencies are listed under "Fire Extinguisher" in the telephone directory. After recharging, secure the extinguisher to its mounting bracket; do not allow it to lie loose on shelves or seats.

# SECTION 8 AIRPLANE HANDLING, SERVICE & MAINTENANCE

## TABLE OF CONTENTS

8-3	Introduction
8-3	Identification Plate
8-3	Cessna Owner Advisories
8-4	Publications
8-4	Airplane File
8-5	Airplane Inspection Periods
8-5	FAA Required Inspections
8-6	Cessna Progressive Care
8-6	Cessna Customer Care Program
8-7	Pilot Conducted Preventive Maintenance
8-7	Alterations or Repairs
8-7	Ground Handling
8-7	Towing
8-8	Parking
8-8	Tie-Down
8-8	Jacking
8-9	Leveling
8-9	Flyable Storage
8-10	Servicing
8-10	Oil
8-10	Fuel
8-12	Landing Gear
8-15	Oxygen
8-16	Cleaning and Care
8-16	Windschild-Windows
8-16	Painted Surfaces
8-17	Stabilizer Abrasion Boot Care
8-17	Propeller Care
8-17	Engine Care
8-18	Interior Care
8-19	Bulb Replacement During Flight

Page

## INTRODUCTION

This section contains factory-recommended procedures for proper ground handling and routine care and servicing of your Cessna. It also identifies certain inspection and maintenance requirements which must be followed if your airplane is to retain that new-plane performance and dependability. It is wise to follow a planned schedule of lubrication and preventive maintenance based on climatic and flying conditions encountered in your locality.

Keep in touch with your Cessna Dealer and take advantage of his knowledge and experience. He knows your airplane and how to maintain it. He will remind you when lubrications and oil changes are necessary, and about other seasonal and periodic services.

## IDENTIFICATION PLATE

All correspondence regarding your airplane should include the SERIAL NUMBER. The Serial Number, Model Number, Production Certificate Number (PC) and Type Certificate Number (TC) can be found on the Identification Plate, located on the left forward doorpost. Located adjacent to the Identification Plate is a Finish and Trim Plate which contains a code describing the interior color scheme and exterior paint combination of the airplane. The code may be used in conjunction with an applicable Parts Catalog if finish and trim information is needed.

## CESSNA OWNER ADVISORIES

Cessna Owner Advisories are sent to Cessna Aircraft owners at no charge to inform them about mandatory and/or beneficial aircraft service requirements and product improvements:

### United States Aircraft Owners

If your aircraft is registered in the U.S., appropriate Cessna Owner Advisories will be mailed to you automatically according to the latest aircraft registration name and address provided to the FAA.

If you require a duplicate Owner Advisory to be sent to an address different from the FAA aircraft registration address, please complete and return an Owner Advisory Application (otherwise no action is required on your part).

### International Aircraft Owners

To receive Cessna Owner Advisories, please complete and return an Owner Advisory Application.

Receipt of a valid Owner Advisory Application will establish your Cessna Owner Advisory service (duplicate Owner Advisory service for U.S. aircraft owners) for one year, after which you will be sent a renewal notice.

## PUBLICATIONS

Various publications and flight operation aids are furnished in the airplane when delivered from the factory. These items are listed below.

- CUSTOMER CARE PROGRAM HANDBOOK
- PILOT'S OPERATING HANDBOOK AND FAA APPROVED AIRPLANE FLIGHT MANUAL
- PILOT'S CHECKLISTS
- POWER COMPUTER
- CESSNA DEALER DIRECTORY
- DO'S AND DON'TS ENGINE BOOKLET

The following additional publications, plus many other supplies that are applicable to your airplane, are available from your Cessna Dealer.

- INFORMATION MANUAL (Contains Pilot's Operating Handbook Information)
- SERVICE MANUALS AND PARTS CATALOGS FOR YOUR:
  - AIRPLANE
  - ENGINE AND ACCESSORIES
  - AVIONICS AND AUTOPILOT

Your Cessna Dealer has a Customer Care Supplies Catalog covering all available items, many of which he keeps on hand. He will be happy to place an order for any item which is not in stock.

### NOTE

A Pilot's Operating Handbook and FAA Approved Airplane Flight Manual which is lost or destroyed may be replaced by contacting your Cessna Dealer. An affidavit containing the owner's name, airplane serial number and registration number must be included in replacement requests since the Pilot's Operating Handbook and FAA Approved Airplane Flight Manual is identified for specific airplanes only.

## AIRPLANE FILE

There are miscellaneous data, information and licenses that are a part

of the airplane file. The following is a checklist for that file. In addition, a periodic check should be made of the latest Federal Aviation Regulations to ensure that all data requirements are met.

- A. To be displayed in the airplane at all times:
  - 1. Aircraft Airworthiness Certificate (FAA Form 8100-2).
  - 2. Aircraft Registration Certificate (FAA Form 8050-3).
  - 3. Aircraft Radio Station License, if transmitter installed (FCC Form 556).
- B. To be carried in the airplane at all times:
  - 1. Pilot's Operating Handbook and FAA Approved Airplane Flight Manual.
  - 2. Weight and Balance, and associated papers (latest copy of the Repair and Alteration Form, FAA Form 337, if applicable).
  - 3. Equipment List.
- C. To be made available upon request:
  - 1. Airplane Log Book.
  - 2. Engine Log Book.

Most of the items listed are required by the United States Federal Aviation Regulations. Since the Regulations of other nations may require other documents and data, owners of airplanes not registered in the United States should check with their own aviation officials to determine their individual requirements.

Cessna recommends that these items, plus the Pilot's Checklist, Power Computer, Customer Care Program Handbook and Customer Care Card, be carried in the airplane at all times.

## AIRPLANE INSPECTION PERIODS

### FAA REQUIRED INSPECTIONS

As required by Federal Aviation Regulations, all civil aircraft of U.S. registry must undergo a complete inspection (annual) each twelve calendar months. In addition to the required ANNUAL inspection, aircraft operated commercially (for hire) must have a complete inspection every 100 hours of operation.

The FAA may require other inspections by the issuance of airworthiness directives applicable to the airplane, engine, propeller and components. It is the responsibility of the owner/operator to ensure compliance with all applicable airworthiness directives and, when the inspections are repetitive, to take appropriate steps to prevent inadvertent noncompliance.

In lieu of the 100 HOUR and ANNUAL inspection requirements, an

airplane may be inspected in accordance with a progressive inspection schedule, which allows the work load to be divided into smaller operations that can be accomplished in shorter time periods.

The Cessna Progressive Care Program has been developed to provide a modern progressive inspection schedule that satisfies the complete airplane inspection requirement of both the 100 HOUR and ANNUAL inspections as applicable to Cessna airplanes. The program assists the owner in his responsibility to comply with all FAA inspection requirement, while ensuring timely replacement of life-limited parts and adherence to factory-recommended inspection intervals and maintenance procedures.

### CESSNA PROGRESSIVE CARE

The Cessna Progressive Care Program has been designed to help you realize maximum utilization of your airplane at a minimum cost and downtime. Under this program, your airplane is inspected and maintained in four operations. The four operations are recycled each 200 hours and are recorded in a specially provided Aircraft Inspection Log as each operation is conducted.

The Cessna Aircraft Company recommends Progressive Care for airplanes that are being flown 200 hours or more per year, and the 100-hour inspection for all other airplanes. The procedures for the Progressive Care Program and the 100-hour inspection have been carefully worked out by the factory and are followed by the Cessna Dealer Organization. The complete familiarity of Cessna Dealers with Cessna equipment and factory-approved procedures provides the highest level of service possible at lower cost to Cessna owners.

Regardless of the inspection method selected by the owner, he should keep in mind that FAR Part 43 and FAR Part 91 establishes the requirement that properly certified agencies or personnel accomplish all required FAA inspections and most of the manufacturer recommended inspections.

### CESSNA CUSTOMER CARE PROGRAM

Specific benefits and provisions of the Cessna Warranty plus other important benefits for you are contained in your Customer Care Program Handbook supplied with your airplane. You will want to thoroughly review your Customer Care Program Handbook and keep it in your airplane at all times.

An initial inspection and either a Progressive Care Operation No.1 or the first 100-hour inspection will be performed within the first 6 months of ownership at no charge to you. If you take delivery from your Dealer, the initial inspection will have been performed before delivery of the

airplane to you. If you pick up your airplane at the factory, plan to take it to your Dealer within 30 days after you take delivery, so the initial inspection may be performed allowing the Dealer to make any minor adjustments which may be necessary.

You will also want to return to your Dealer either at 50 hours for your first Progressive Care Operation, or at 100 hours for your first 100-hour inspection depending on which program you choose to establish for your airplane. While these important inspections will be performed for you by any Cessna Dealer, in most cases you will prefer to have the Dealer from whom you purchased the airplane accomplish this work.

## PILOT CONDUCTED PREVENTIVE MAINTENANCE

A certified pilot who owns or operates an airplane not used as an air carrier is authorized by FAR Part 43 to perform limited maintenance on his airplane. Refer to FAR Part 43 for a list of the specific maintenance operations which are allowed.

### NOTE

Pilots operating airplanes of other than U.S. registry should refer to the regulations of the country of certification for information on preventive maintenance that may be performed by pilots.

A Service Manual should be obtained prior to performing any preventive maintenance to ensure that proper procedures are followed. Your Cessna Dealer should be contacted for further information or for required maintenance which must be accomplished by appropriately licensed personnel.

## ALTERATIONS OR REPAIRS

It is essential that the FAA be contacted prior to any alterations on the airplane to ensure that airworthiness of the airplane is not violated. Alterations or repairs to the airplane must be accomplished by licensed personnel.

## GROUND HANDLING

### TOWING

The airplane is most easily and safely maneuvered by hand with the tow-bar attached to the nose wheel. The tow-bar is stowed under the rear seat using two clips, one attached to the center leg of the seat and one sec-

ured to the floorboard under the left side of the seat. When towing with a vehicle, do not exceed the nose gear turning angle of 29° either side of center, or damage to the gear will result.

#### CAUTION

Remove any installed rudder lock before towing.

If the airplane is towed or pushed over a rough surface during hanging, watch that the normal cushioning action of the nose strut does not cause excessive vertical movement of the tail and the resulting contact with low hangar doors or structure. A flat nose tire or deflated strut will also increase tail height.

### PARKING

When parking the airplane, head into the wind and set the parking brakes. Do not set the parking brakes during cold weather when accumulated moisture may freeze the brakes, or when the brakes are overheated. Close the cowl flaps, install the control wheel lock and chock the wheels. In severe weather and high wind conditions, tie the airplane down as outlined in the following paragraph.

### TIE-DOWN

Proper tie-down procedure is the best precaution against damage to the parked airplane by gusty or strong winds. To tie-down the airplane securely, proceed as follows:

1. Set the parking brake and install the control wheel lock.
2. Install a surface control lock over the fin and rudder.
3. Tie sufficiently strong ropes or chains (700 pounds tensile strength) to the wing and tail tie-down fittings and secure each rope to a ramp tie-down.
4. Tie a rope (no chains or cables) to the nose gear torque link and secure to a ramp tie-down.
5. Install a pitot tube cover.

### JACKING

When a requirement exists to jack the entire airplane off the ground, or when wing jack points are used in the jacking operation, refer to the Service Manual for specific procedures and equipment required.

Individual main gear may be jacked by using the jack pad which is incorporated in the main landing gear strut step assembly. When using the individual gear strut jack pad, flexibility of the gear strut will cause the main wheel to slide inboard as the wheel is raised, tilting the jack. The jack



must then be lowered for a second jacking operation. Do not jack both main wheels simultaneously using the individual main gear jack pads.

If nose gear maintenance is required, the nose wheel may be raised off the ground by pressing down on a tailcone bulkhead, just forward of the horizontal stabilizer, and allowing the tail to rest on the tail tie-down ring.

**CAUTION**

Do not apply pressure on the elevator or outboard stabilizer surfaces. When pushing on the tailcone, always apply pressure at a bulkhead to avoid buckling the skin.

To assist in raising and holding the nose wheel off the ground, weight down the tail by placing sand-bags, or suitable weights, on each side of the horizontal stabilizer, next to the fuselage. If ground anchors are available, the tail should be securely tied down.

**NOTE**

Ensure that the nose will be held off the ground under all conditions by means of suitable stands or supports under weight supporting bulkheads near the nose of the airplane.

**LEVELING**

Longitudinal leveling of the airplane is accomplished by placing a level on the leveling screws located on the left side of the tailcone. Deflate the nose tire and/or lower or raise the nose strut to properly center the bubble in the level. Corresponding points on both upper door sills may be used to level the airplane laterally.

**FLYABLE STORAGE**

Airplanes placed in non-operational storage for a maximum of 30 days or those which receive only intermittent operational use for the first 25 hours are considered in flyable storage status. Every seventh day during these periods, the propeller should be rotated by hand through five revolutions. This action "limbers" the oil and prevents any accumulation of corrosion on engine cylinder walls.

**WARNING**

For maximum safety, check that the ignition switch is OFF, the throttle is closed, the mixture control is in the idle cut-off position, and the airplane is secured before rotating the propeller by hand. Do not stand within the arc of the propeller blades while turning the propeller.

After 30 days, the airplane should be flown for 30 minutes or a ground

runup should be made just long enough to produce an oil temperature within the lower green arc range. Excessive ground runup should be avoided.

Engine runup also helps to eliminate excessive accumulations of water in the fuel system and other air spaces in the engine. Keep fuel tanks full to minimize condensation in the tanks. Keep the battery fully charged to prevent the electrolyte from freezing in cold weather. If the airplane is to be stored temporarily, or indefinitely, refer to the Service Manual for proper storage procedures.

## SERVICING

In addition to the PREFLIGHT INSPECTION covered in Section 4, COMPLETE servicing, inspection, and test requirements for your airplane are detailed in the Service Manual. The Service Manual outlines all items which require attention at 50, 100, and 200 hour intervals plus those items which require servicing, inspection, and/or testing at special intervals.

Since Cessna Dealers conduct all service, inspection, and test procedures in accordance with applicable Service Manuals, it is recommended that you contact your Cessna Dealer concerning these requirements and begin scheduling your airplane for service at the recommended intervals.

Cessna Progressive Care ensures that these requirements are accomplished at the required intervals to comply with the 100-hour or ANNUAL inspection as previously covered.

Depending on various flight operations, your local Government Aviation Agency may require additional service, inspections, or tests. For these regulatory requirements, owners should check with local aviation officials where the airplane is being operated.

For quick and ready reference, quantities, materials, and specifications for frequently used service items are as follows:

### OIL

#### OIL SPECIFICATION --

The airplane was delivered from the factory with a corrosion preventive aircraft engine oil. This oil should be drained after the first 25 hours of operation.

MIL-L-6082 Aviation Grade Straight Mineral Oil: Use to replenish supply during the first 25 hours.

Continental Motors Specification MHS-24 Aviation Grade Ashless Dis-

persant Oil: Oil conforming to Continental Motors Specification MHS-24, and all revisions or supplements thereto, must be used after first 25 hours. Refer to Continental Aircraft Engine Service Bulletin M82-8, and any superseding bulletins, revisions, or supplements thereto, for further recommendations.

**RECOMMENDED VISCOSITY FOR TEMPERATURE RANGE--**

All temperatures, use multi-viscosity oil or  
Above 4°C (40°F), use SAE 50.  
Below 4°C (40°F), use SAE 30.

**NOTE**

When operating temperatures overlap, use the lighter grade of oil. Multi-viscosity oil is recommended for improved starting in cold weather.

**CAPACITY OF ENGINE SUMP -- 12 Quarts.**

Do not operate on less than 9 quarts. To minimize loss of oil through breather, fill to 10 quart level for normal flights of less than 3 hours. For extended flight, fill to 12 quarts. These quantities refer to oil dipstick level readings. During oil and oil filter changes, one additional quart is required.

**OIL AND OIL FILTER CHANGE --**

After the first 25 hours of operation, drain engine oil sump and change the filter. Refill sump with ashless dispersant oil. Drain the engine oil sump and change the filter each 50 hours thereafter. The oil change interval may be extended to 100-hour intervals, providing the oil filter is changed at 50-hour intervals. Change engine oil and filter at least every 6 months even though less than the recommended hours have accumulated. Reduce intervals for prolonged operation in dusty areas, cold climates, or when short flights and long idle periods result in sludging conditions.

**NOTE**

During the first 25-hour oil and filter change, a general inspection of the overall engine compartment is required. Items which are not normally checked during a preflight inspection should be given special attention. Hoses, metal lines and fittings should be inspected for signs of oil and fuel leaks, and checked for abrasions, chafing, security, proper routing and support, and evidence of deterioration. Inspect the intake and exhaust systems for cracks, evidence of leakage, and security of attachment. Engine controls and linkages should be checked for freedom of movement through their full range, security of attachment and evidence of wear. Inspect wiring for security, chafing,

burning, defective insulation, loose or broken terminals, heat deterioration, and corroded terminals. Check the alternator belt in accordance with Service Manual instructions, and retighten if necessary. A periodic check of these items during subsequent servicing operations is recommended.

## FUEL

### APPROVED FUEL GRADES (AND COLORS) --

100LL Grade Aviation Fuel (Blue).

100 (Formerly 100/130) Grade Aviation Fuel (Green).

#### NOTE

Isopropyl alcohol or ethylene glycol monomethyl ether may be added to the fuel supply in quantities not to exceed 1% or .15% by volume, respectively, of the total. Refer to Fuel Additives in later paragraphs for additional information.

CAPACITY EACH TANK -- 46.0 U.S. Gallons.

REDUCED CAPACITY EACH TANK (WHEN FILLED TO BOTTOM OF FUEL FILLER NECK) -- 34.5 Gallons.

#### NOTE

To ensure maximum fuel capacity when refueling and minimize cross-feeding when parked on a sloping surface, place the fuel selector valve handle in either LEFT or RIGHT position.

#### NOTE

Service the fuel system after each flight, and keep fuel tanks full to minimize condensation in the tanks.

### FUEL ADDITIVES --

Strict adherence to recommended preflight draining instructions as called for in Section 4 will eliminate any free water accumulations from the tank sumps. While small amounts of water may still remain in solution in the gasoline, it will normally be consumed and go unnoticed in the operation of the engine.

One exception to this can be encountered when operating under the combined effect of: (1) use of certain fuels, with (2) high humidity conditions on the ground followed by (3) flight at high altitude and low temperature. Under these unusual conditions, small amounts of water in solution can precipitate from the fuel stream and freeze in sufficient quantities to induce partial icing of the engine fuel system.

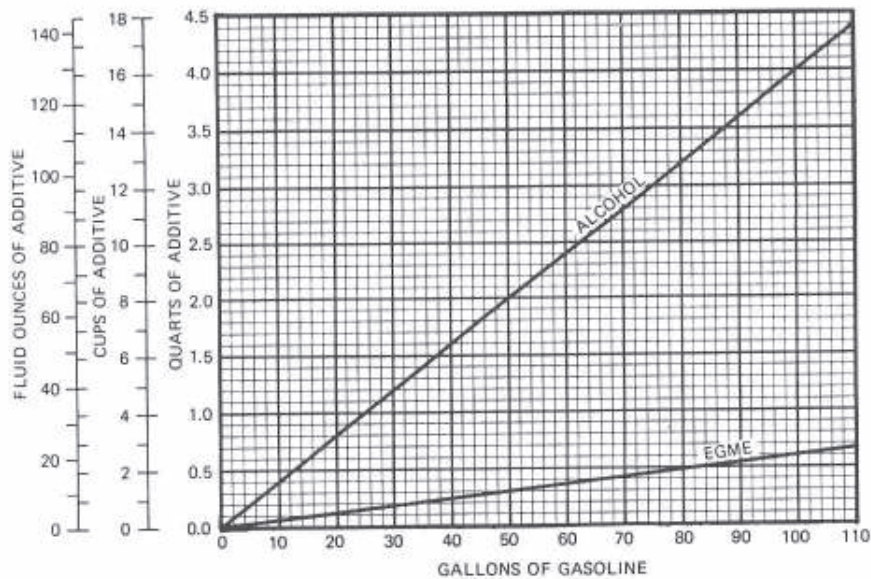

Figure 8-1. Additive Mixing Ratio

While these conditions are quite rare and will not normally pose a problem to owners and operators, they do exist in certain areas of the world and consequently must be dealt with, when encountered.

Therefore, to alleviate the possibility of fuel icing occurring under these unusual conditions, it is permissible to add isopropyl alcohol or ethylene glycol monomethyl ether (EGME) compound to the fuel supply.

The introduction of alcohol or EGME compound into the fuel provides two distinct effects: (1) it absorbs the dissolved water from the gasoline and (2) alcohol has a freezing temperature depressant effect.

Alcohol, if used, is to be blended with the fuel in a concentration of 1% by volume. Concentrations greater than 1% are not recommended since they can be detrimental to fuel tank materials.

The manner in which the alcohol is added to the fuel is significant because alcohol is most effective when it is completely dissolved in the fuel. To ensure proper mixing, the following is recommended:

1. For best results, the alcohol should be added during the fueling

operation by pouring the alcohol directly on the fuel stream issuing from the fueling nozzle.

2. An alternate method that may be used is to premix the complete alcohol dosage with some fuel in a separate clean container (approximately 2-3 gallon capacity) and then transferring this mixture to the tank prior to the fuel operation.

Isopropyl alcohol with a maximum water content not to exceed 0.4% by volume must be used, such as anti-icing fluid (MIL-F-5566) or isopropyl alcohol (Federal Specification TT-I-735a). Figure 8-1 provides alcohol-fuel mixing ratio information.

Ethylene glycol monomethyl ether (EGME) compound, in compliance with MIL-I-27686 or Phillips PFA-55MB, if used, must be carefully mixed with the fuel in concentrations not to exceed .15% by volume. Figure 8-1 provides EGME-fuel mixing ratio information.

**CAUTION**

Mixing of the EGME compound with the fuel is extremely important because a concentration in excess of that recommended (.15% by volume maximum) will result in detrimental effects to the fuel tanks, such as deterioration of protective primer and sealants and damage to O-rings and seals in the fuel system and engine components. Use only blending equipment that is recommended by the manufacturer to obtain proper proportioning.

**CAUTION**

Do not allow the concentrated EGME compound to come in contact with the airplane finish or fuel cell as damage can result.

Prolonged storage of the airplane will result in a water buildup in the fuel which "leeches out" the additive. An indication of this is when an excessive amount of water accumulates in the fuel tank sumps. The concentration can be checked using a differential refractometer. It is imperative that the technical manual for the differential refractometer be followed explicitly when checking the additive concentration.

**FUEL CONTAMINATION --**

Fuel contamination is usually the result of foreign material present in the fuel system, and may consist of water, rust, sand, dirt, microbes or bacterial growth. In addition, additives that are not compatible with fuel or fuel system components can cause the fuel to become contaminated.

Before the first flight of the day and after each refueling, use a clear sampler cup and drain at least a cupful of fuel from the fuel tank sump quick-drain valves to determine if contaminants are present, and that the airplane has been fueled with the proper grade of fuel. Also, the fuel strainer should be drained by pulling out the strainer knob for at least four seconds. If contamination is detected, drain all fuel drain points again, including the fuel selector valve drain plug, and then gently rock the wings and lower the tail to the ground to move any additional contaminants to the sampling points. Take repeated samples from all fuel drain points until all contamination has been removed. If, after repeated sampling, evidence of contamination still exists, the fuel tanks should be completely drained and the fuel system cleaned. If the airplane has been serviced with the improper fuel grade, defuel completely and refuel with the correct grade. **Do not fly the airplane with contaminated or unapproved fuel.**

In addition, Owners/Operators who are not acquainted with a particular fixed base operator should be assured that the fuel supply has been checked for contamination and is properly filtered before allowing the airplane to be serviced. Also, fuel tanks should be kept full between flights, provided weight and balance considerations will permit, to reduce the possibility of water condensing on the walls of partially filled tanks.

To further reduce the possibility of contaminated fuel, routine maintenance of the fuel system should be performed in accordance with the airplane Service Manual. Only the proper fuel, as recommended in this handbook, should be used, and fuel additives should not be used unless approved by Cessna and the Federal Aviation Administration.

## LANDING GEAR

NOSE WHEEL TIRE PRESSURE -- 49 PSI on 5.00-5, 6-Ply Rated Tire.  
MAIN WHEEL TIRE PRESSURE -- 42 PSI on 6.00-6, 6-Ply Rated Tires.  
NOSE GEAR SHOCK STRUT --

Keep filled with MIL-H-5606 hydraulic fluid per filling instructions placard, and with no load on the strut, inflate with air to 55-60 PSI. Do not over-inflate.

BRAKES -- Service as required with MIL-H-5606 hydraulic fluid.

## OXYGEN

AVIATOR'S BREATHING OXYGEN -- Spec. No. MIL-O-27210.  
MAXIMUM PRESSURE (cylinder temperature stabilized after filling) -- 1800 PSI at 21°C (70°F). Refer to Oxygen Supplement (Section 9) for filling pressures.

## CLEANING AND CARE

### WINDSHIELD-WINDOWS

The plastic windshield and windows should be cleaned with an aircraft windshield cleaner. Apply the cleaner sparingly with soft cloths, and rub with moderate pressure until all dirt, oil scum and bug stains are removed. Allow the cleaner to dry, then wipe it off with soft flannel cloths.

If a windshield cleaner is not available, the plastic can be cleaned with soft cloths moistened with Stoddard solvent to remove oil and grease.

#### NOTE

**Never use** gasoline, benzine, alcohol, acetone, fire extinguisher or anti-ice fluid, lacquer thinner or glass cleaner to clean the plastic. These materials will attack the plastic and may cause it to craze.

Follow by **carefully** washing with a mild detergent and plenty of water. Rinse thoroughly, then dry with a clean moist chamois. **Do not rub** the plastic with a dry cloth since this builds up an electrostatic charge which attracts dust. Waxing with a good commercial wax will finish the cleaning job. A thin, even coat of wax, polished out by hand with clean soft flannel cloths, will fill in minor scratches and help prevent further scratching.

**Do not use** a canvas cover on the windshield unless freezing rain or sleet is anticipated since the cover may scratch the plastic surface.

### PAINTED SURFACES

The painted exterior surfaces of your new Cessna have a durable, long lasting finish. Approximately 10 days are required for the paint to cure completely; in most cases, the curing period will have been completed prior to delivery of the airplane. In the event that polishing or buffing is required within the curing period, it is recommended that the work be done by someone experienced in handling uncured paint. Any Cessna Dealer can accomplish this work.

Generally, the painted surfaces can be kept bright by washing with water and mild soap, followed by a rinse with water and drying with cloths or a chamois. Harsh or abrasive soaps or detergents which cause corrosion or scratches should never be used. Remove stubborn oil and grease with a cloth moistened with Stoddard solvent.

To seal any minor surface chips or scratches and protect against corrosion, the airplane should be waxed regularly with a good automotive wax applied in accordance with the manufacturer's instructions. If the airplane



is operated in a seacoast or other salt water environment, it must be washed and waxed more frequently to assure adequate protection. Special care should be taken to seal around rivet heads and skin laps, which are the areas most susceptible to corrosion. A heavier coating of wax on the leading edges of the wings and tail and on the cowl nose cap and propeller spinner will help reduce the abrasion encountered in these areas. Reapplication of wax will generally be necessary after cleaning with soap solutions or after chemical de-icing operations.

When the airplane is parked outside in cold climates and it is necessary to remove ice before flight, care should be taken to protect the painted surfaces during ice removal with chemical liquids. Isopropyl alcohol will satisfactorily remove ice accumulations without damaging the paint. However, keep the isopropyl alcohol away from the windshield and cabin windows since it will attack the plastic and may cause it to craze.

### STABILIZER ABRASION BOOT CARE

If the airplane is equipped with stabilizer abrasion boots, keep them clean and free from oil and grease which can swell the rubber. Wash them with mild soap and water, using Form Tech AC cleaner or naphtha to remove stubborn grease. Do not scrub the boots, and be sure to wipe off all solvent before it dries. Boots with loosened edges or small tears should be repaired. Your Cessna Dealer has the proper material and know-how to do this correctly.

### PROPELLER CARE

Preflight inspection of propeller blades for nicks, and wiping them occasionally with an oily cloth to clean off grass and bug stains will assure long blade life. Small nicks on the propeller, particularly near the tips and on the leading edges, should be dressed out as soon as possible since these nicks produce stress concentrations, and if ignored, may result in cracks. Never use an alkaline cleaner on the blades: remove grease and dirt with Stoddard solvent.

### ENGINE CARE

The engine may be cleaned, using a suitable solvent, in accordance with instructions in the airplane Service Manual. Most efficient cleaning is done using a spray-type cleaner. Before spray cleaning, ensure that protection is afforded for components which might be adversely affected by the solvent. Refer to the Service Manual for proper lubrication of controls and components after engine cleaning.

## INTERIOR CARE

To remove dust and loose dirt from the upholstery and carpet, clean the interior regularly with a vacuum cleaner.

Blot up any spilled liquid promptly with cleansing tissue or rags. Don't pat the spot; press the blotting material firmly and hold it for several seconds. Continue blotting until no more liquid is taken up. Scrape off sticky materials with a dull knife, then spot-clean the area.

Oily spots may be cleaned with household spot removers, used sparingly. Before using any solvent, read the instructions on the container and test it on an obscure place on the fabric to be cleaned. Never saturate the fabric with a volatile solvent; it may damage the padding and backing materials.

Soiled upholstery and carpet may be cleaned with foam-type detergent, used according to the manufacturer's instructions. To minimize wetting the fabric, keep the foam as dry as possible and remove it with a vacuum cleaner.

If your airplane is equipped with leather seating, cleaning of the seats is accomplished using a soft cloth or sponge dipped in mild soap suds. The soap suds, used sparingly, will remove traces of dirt and grease. The soap should be removed with a clean damp cloth.

The plastic trim, headliner, instrument panel and control knobs need only be wiped off with a damp cloth. Oil and grease on the control wheel and control knobs can be removed with a cloth moistened with Stoddard solvent. Volatile solvents, such as mentioned in paragraphs on care of the windshield, must never be used since they soften and craze the plastic.

## BULB REPLACEMENT DURING FLIGHT

Figure 8-2 provides instructions to aid the pilot in the replacement of defective light bulbs during flight without tools. It is suggested that spare bulbs be stored in the map compartment. However, if a spare bulb is not available, an identical bulb which is found to be available from other lights listed herein can be substituted for the defective bulb. For a listing of other bulb requirements and specific tools needed, refer to the Service Manual for this airplane.

### CONTROL WHEEL MAP LIGHT

Grasp rim of bulb, push straight up and turn counterclockwise as far as possible, then pull bulb straight down and out of socket. Replace with 24RB bulb. To install new bulb in socket, align pins on bulb with slots in socket, then push straight up and rotate bulb clockwise as far as possible.

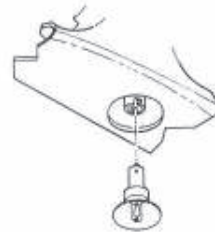

### POST LIGHTS

Grasp lens cap and pull straight out from socket. Pull bulb from cap and replace with MS25237-327 bulb. Replace cap in socket and rotate cap to direct light in desired direction.

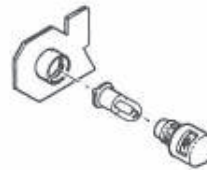

Figure 8-2. Bulb Replacement

# SECTION 9 SUPPLEMENTS

## (Optional Systems Description & Operating Procedures)

### TABLE OF CONTENTS

#### Introduction

#### General:

1	Carburetor Air Temperature Gage . . . . .	(2 pages)
2	Convenience Table . . . . .	(2 pages)
3	Digital Clock . . . . .	(4 pages)
4	Electric Elevator Trim System . . . . .	(4 pages)
5	Ground Service Plug Receptacle . . . . .	(4 pages)
6	Oxygen System . . . . .	(6 pages)
7	Standby Vacuum Pump . . . . .	(4 pages)
8	Strobe Light System . . . . .	(2 pages)
9	Winterization Kit . . . . .	(2 pages)

#### Avionics:

31	Audio Control Panels . . . . .	(8 pages)
32	Cassette Stereo AM/FM Entertainment Center (Type EC-100) . . . . .	(8 pages)
37	Emergency Locator Transmitter (ELT) . . . . .	(4 pages)
42A	SMD-77A DME (Type RT-377A) . . . . .	(4 pages)
45	SSB HF Transceiver (Type ASB-125) . . . . .	(4 pages)
46	Unslaved Horizontal Situation Indicator (Type IG-832C) . . . . .	(4 pages)
60	200A Navomatic Autopilot (Type AF-295B) . . . . .	(6 pages)
62	300 ADF (Type R-546E) . . . . .	(6 pages)
64	300 Nav/Com (Type RT-385A) . . . . .	(8 pages)
66	300 Transponder (Type RT-359A) And Optional Altitude Encoder (Blind) . . . . .	(6 pages)
68	300 Transponder (Type RT-359A) And Optional Encoding Altimeter (Type EA-401A) . . . . .	(6 pages)
69	300A Navomatic Autopilot (Type AF-395A) . . . . .	(8 pages)
71	400 ADF (Type R-446A) . . . . .	(6 pages)
72	400 Area Navigation System (Type RN-479A) . . . . .	(10 pages)
72A	400 DME (Type R-476A) . . . . .	(4 pages)
73	400 DME (Type R-477A) . . . . .	(4 pages)
76	400 Glide Slope (Type R-443B) . . . . .	(4 pages)

**TABLE OF CONTENTS (Continued)**

78	400 Marker Beacon (Type R-402) . . . . .	(6 pages)
79	400 Nav/Com (Type RT-485B) . . . . .	(12 pages)
84	400 Transponder (Type RT-459A) And Optional Altitude Encoder (Blind) . . . . .	(6 pages)
87	400 Transponder (Type RT-459A) And Optional Encoding Altimeter (Type EA-401A) . . . . .	(6 pages)

## INTRODUCTION

This section consists of a series of supplements, each covering a single optional system which may be installed in the airplane. Each supplement contains a brief description, and when applicable, operating limitations, emergency and normal procedures, and performance. As listed in the Table of Contents, the supplements are classified under the headings of General and Avionics, and have been provided with reference numbers. Also, the supplements are arranged alphabetically and numerically to make it easier to locate a particular supplement. Other routinely installed items of optional equipment, whose function and operational procedures do not require detailed instructions, are discussed in Section 7.

Limitations contained in the following supplements are FAA approved. Observance of these operating limitations is required by Federal Aviation Regulations.

## SUPPLEMENT

# CARBURETOR AIR TEMPERATURE GAGE

### SECTION 1 GENERAL

The carburetor air temperature gage provides a means of detecting carburetor icing conditions. The gage is located on the left side of the instrument panel below the gyros. It is marked in 5° increments from -30°C to +30°C, and has a yellow arc between -15°C and +5°C which indicates the temperature range most conducive to carburetor icing.

### SECTION 2 LIMITATIONS

There is no change to the airplane limitations when the carburetor air temperature gage is installed.

### SECTION 3 EMERGENCY PROCEDURES

There is no change to the airplane emergency procedures when the carburetor air temperature gage is installed.

### SECTION 4 NORMAL PROCEDURES

There is no change to the airplane normal procedures when the carburetor air temperature gage is installed. It is good practice to monitor the gage periodically and keep the needle out of the yellow arc during possible carburetor icing conditions. Refer to Section 4 of the basic

handbook for procedures used when operating with carburetor heat applied.

## SECTION 5 PERFORMANCE

There is no change to the airplane performance when the carburetor air temperature gage is installed. However, if it is necessary to operate with carburetor heat applied, a small performance loss may be expected at any given power setting due to the warmer induction air temperature.



## SUPPLEMENT

### CONVENIENCE TABLE

#### SECTION 1 GENERAL

The convenience table and its stowage compartment is installed on the back of the pilot's or copilot's seat for use by the second row passengers. The table is equipped with guides which follow tracks inside the stowage compartment.

#### SECTION 2 LIMITATIONS

The following information must be presented in the form of a placard located on the back of the convenience table.

STOW LEAF DURING TAKEOFF AND LANDING
---

#### SECTION 3 EMERGENCY PROCEDURES

There is no change to the airplane emergency procedures when the convenience table is installed.

# SUPPLEMENT

## DIGITAL CLOCK

### SECTION 1 GENERAL

The Astro Tech LC-2 Quartz Chronometer (see figure 1) is a precision, solid state time keeping device which will display to the pilot the time-of-day, the calendar date, and the elapsed time interval between a series of selected events, such as in-flight check points or legs of a cross-country flight, etc. These three modes of operation function independently and can be alternately selected for viewing on the four digit liquid crystal display (LCD) on the front face of the instrument. Three push button type switches directly below the display control all time keeping functions. These control functions are summarized in figures 2 and 3.

The digital display features an internal light (back light) to ensure good visibility under low cabin lighting conditions or at night. The intensity of the back light is controlled by the ENG-RADIO lights rheostat. In addition, the display incorporates a test function (see figure 1) which allows checking that all elements of the display are operating. To activate the test function, press the LH and RH buttons at the same time.

### SECTION 2 LIMITATIONS

There is no change to the airplane limitations when the digital clock is installed.

### SECTION 3 EMERGENCY PROCEDURES

There is no change to the airplane emergency procedures when the digital clock is installed.

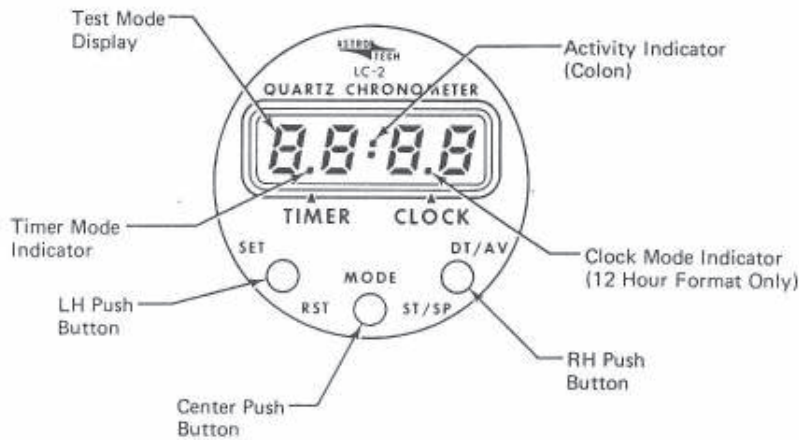

Figure 1. Digital Clock

## SECTION 4 NORMAL PROCEDURES

### CLOCK AND DATE OPERATION

When operating in the clock mode (see figure 2), the display shows the time of day in hours and minutes while the activity indicator (colon) will blink off for one second each ten seconds to indicate proper functioning. If the RH push button is pressed momentarily, while in the clock mode, the calendar date appears numerically on the display with month of year to the left of the colon and day of the month shown to the right of the colon. The display automatically returns to the clock mode after approximately 1.5 seconds. However, if the RH button is pressed continuously longer than approximately two seconds, the display will return from the date to the clock mode with the activity indicator (colon) blinking altered to show continuously or be blanked completely from the display. Should this occur, simply press the RH button again for two seconds or longer, and correct colon blinking will be restored.

#### NOTE

The clock mode is set at the factory to operate in the 24-hour format. However, 12-hour format operation may be selected by changing the position of an internal slide

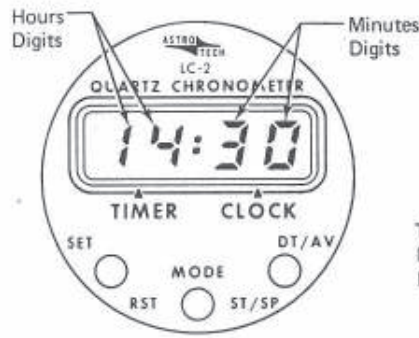

LH Button: Sets date and time of day (when used with RH button).

Center Button: Alternately displays clock or timer status

RH Button: Shows calendar date momentarily; display returns to clock mode after 1.5 Seconds.

Figure 2. Clock Mode

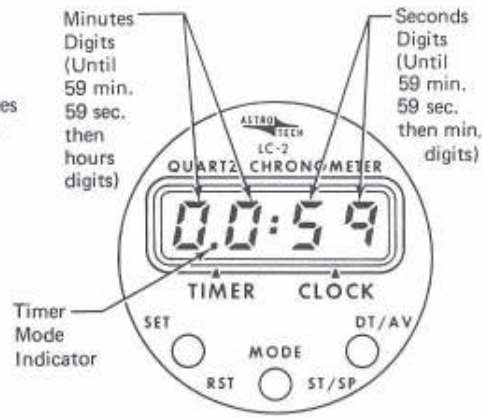

LH Button: Resets timer to "zero".

Center Button: Alternately displays clock or timer status

RH Button: Alternately starts and stops timer; timer starts from any previously accumulated total.

Figure 3. Timer Mode

switch accessible through a small hole on the bottom of the instrument case. Notice that in the 24-hour format, the clock mode indicator does not appear.

SETTING CORRECT DATE AND TIME

The correct date and time are set while in the clock mode using the LH and RH push buttons as follows: press the LH button once to cause the date to appear with the month flashing. Press the RH button to cause the month to advance at one per second (holding button), or one per push until the correct month appears. Push the LH button again to cause the day of month to appear flashing, then advance as before using RH button until correct day of month appears.

Once set correctly, the date advances automatically at midnight each day. February 29 of each leap year is not programmed into the calendar

mode, and the date will advance to March 1. This may be corrected the following day by resetting the mode back to March 1.

Pressing the LH button two additional times will cause the time to appear with the hours digits flashing. Using the RH button as before, advance the hour digits to the correct hour as referenced to a known time standard. Another push of the LH button will now cause the minutes digits to flash. Advance the minutes digits to the next whole minute to be reached by the time standard and "hold" the display by pressing the LH button once more. At the exact instant the time standard reaches the value "held" by the display, press the RH button to restart normal clock timing, which will now be synchronized to the time standard.

In some instances, however, it may not be necessary to advance the minutes digits of the clock; for example when changing time zones. In such a case, do not advance the minutes digits while they are flashing. Instead, press the LH button again, and the clock returns to the normal time keeping mode without altering the minutes timing.

#### TIMER OPERATION

The completely independent 24-hour elapsed timer (see figure 3) is operated as follows: press the center (MODE) push button until the timer mode indicator appears. Reset the display to "zero" by pressing the LH button. Begin timing an event by pressing the RH button. The timer will begin counting in minutes and seconds and the colon (activity indicator) will blink off for 1/10 second each second. When 59 minutes 59 seconds have accumulated, the timer changes to count in hours and minutes up to a maximum of 23 hours, 59 minutes. During the count in hours and minutes, the colon blinks off for one second each ten seconds. To stop timing the event, press the RH button once again and the time shown by the display is "frozen". Successive pushes of the RH button will alternately restart the count from the "held" total or stop the count at a new total. The hold status of the timer can be recognized by lack of colon activity, either continuously on or continuously off. The timer can be reset to "zero" at anytime using the LH button.

## SECTION 5 PERFORMANCE

There is no change to the airplane performance when the digital clock is installed.

# SUPPLEMENT

## ELECTRIC ELEVATOR TRIM SYSTEM

### SECTION 1 GENERAL

The electric elevator trim system provides a simple method of relieving pitch control pressures without interrupting other control operations to adjust the elevator trim wheel. The system is controlled by a dual-segmented, 3-position trim switch with each segment labeled DN and UP, a red momentary push button autopilot disengage/trim disconnect switch labeled AP/TRIM DISC, and a "pull-off" type circuit breaker, labeled ELEC TRIM. The dual segmented trim switch and push button autopilot disengage/trim disconnect switch are located on the left control wheel grip; the "pull-off" circuit breaker is on the left side of the switch and control panel. Simultaneously pushing the dual segments of the trim switch forward to the DN position moves the elevator trim tab and the trim wheel in the "nose down" direction; conversely, pulling the dual segments aft to the UP position moves the tab and trim wheel in the "nose up" direction. The dual segments of the trim switch are spring-loaded to automatically return to the center off position when they are released from the DN or UP positions, thus stopping movement of the trim tab and elevator trim wheel.

During normal operation of the electric elevator trim system, a trim actuator (which includes an electric motor, a solenoid gear engage mechanism, and an override slip clutch) moves the trim tab in the selected direction. When the dual segments of the trim switch are in the center off position, the trim actuator is disconnected from the trim system and does not impede manual adjustment of the trim tab by the elevator trim wheel.

### SECTION 2 LIMITATIONS

Prior to each flight during which the electric elevator trim system will be used, a preflight check of the system safety features must be made as discussed in the Normal Procedures section of this supplement.

### SECTION 3 EMERGENCY PROCEDURES

1. Elevator Control -- OVERPOWER as required.
2. AP/TRIM DISC Push Button -- PUSH and RELEASE.
3. ELEC TRIM Circuit Breaker -- PULL OFF for the remainder of the flight.
4. Manual Trim -- AS REQUIRED.

### SECTION 4 NORMAL PROCEDURES

#### BEFORE TAKEOFF

The following electric elevator trim system checks must be made prior to flight:

1. Elevator Trim Switch Segments -- INDIVIDUALLY PUSH FORWARD to DN position and HOLD momentarily, OBSERVE NO MOVEMENT of elevator trim wheel, then release trim switch to center off position.
2. Elevator Trim Switch Segments -- INDIVIDUALLY PULL AFT to UP position and HOLD momentarily, OBSERVE NO MOVEMENT of elevator trim wheel, then release trim switch to center off position.

#### NOTE

If movement of the elevator trim wheel is noted during steps 1 or 2, the electric elevator trim system has malfunctioned. The flight may be continued if the electric trim circuit breaker is pulled to the off position to render the system inoperative until such time as repairs can be made.

3. Both Segments of Electric Elevator Trim Switch -- PUSH FORWARD SIMULTANEOUSLY and HOLD and OBSERVE MOVEMENT of elevator trim wheel and elevator trim tab in proper direction.
4. AP/TRIM DISC Pushbutton -- MOMENTARILY DEPRESS and observe that movement of the elevator trim system stops.
5. Elevator Trim Switch -- RELEASE TO CENTER OFF POSITION to reactivate system.

6. Both Segments of Electric Elevator Trim Switch -- Repeat steps 3, 4, and 5 in opposite direction.

**NOTE**

If movement of the elevator trim wheel is observed after the AP/TRIM DISC pushbutton is depressed and released during step 4, the elevator trim has malfunctioned. The ELECT TRIM circuit breaker should be pulled to the off position to render the system inoperative.

**INFLIGHT**

To operate the electric elevator trim system during flight, proceed as follows:

1. Master Switch -- ON.
2. Elevator Trim Circuit Breaker -- CHECK IN.
3. Dual Segmented Trim Switch -- ACTUATE as desired.
4. Elevator Trim Position Indicator -- CHECK.

**SECTION 5**  
**PERFORMANCE**

There is no change to the airplane performance when the electric elevator trim system is installed.



## SUPPLEMENT

# GROUND SERVICE PLUG RECEPTACLE

### SECTION 1 GENERAL

The ground service plug receptacle permits the use of an external power source for cold weather starting and during lengthy maintenance work on the electrical and avionics equipment. The receptacle is located behind a door on the left side of the fuselage aft of the baggage compartment door.

#### NOTE

If no avionics equipment is to be used or worked on, the avionics power switch should be turned off. If maintenance is required on the avionics equipment, it is advisable to utilize a battery cart external power source to prevent damage to the avionics equipment by transient voltage. Do not crank or start the engine with the avionics power switch turned on.

A special fused circuit is included with the ground service plug receptacle which will close the battery contactor when external power is applied with the master switch turned on. This circuit is intended as a servicing aid when battery power is too low to close the contactor, and should not be used to avoid performing proper maintenance procedures on a low battery.

#### NOTE

Use of the ground service plug receptacle for starting an airplane with a "dead" battery or charging a "dead" battery in the airplane is not recommended. The battery should be removed from the airplane and serviced in accordance with Service Manual procedures. Failure to observe this precaution could result in loss of electrical power during flight.

## SECTION 2 LIMITATIONS

The following information must be presented in the form of a placard located on the inside of the ground service plug access door:

<p><b>CAUTION</b></p> <p>This aircraft is equipped with alternator and a negative ground system. <b>OBSERVE PROPER POLARITY</b> Reverse polarity will damage electrical components.</p>	<p><b>24 VOLTS D.C.</b></p>
---	-----------------------------

## SECTION 3 EMERGENCY PROCEDURES

There is no change to the airplane emergency procedures when the ground service plug receptacle is installed.

## SECTION 4 NORMAL PROCEDURES

Just before connecting an external power source (generator type or battery cart), the avionics power switch should be turned off, and the master switch turned on.

### WARNING

When turning on the master switch, using an external power source, or pulling the propeller through by hand, treat the propeller as if the ignition switch were ON. Do not stand, nor allow anyone else to stand, within the arc of the propeller, since a loose or broken wire or a component malfunction could cause the propeller to rotate.

The ground service plug receptacle circuit incorporates a polarity reversal protection. Power from the external power source will flow only if the ground service plug is correctly connected to the airplane. If the plug is accidentally connected backwards, no power will flow to the electrical system, thereby preventing any damage to electrical equipment.

The following check should be made after engine start and removal of the external power source, if there is any question as to the condition of the battery.

1. Master Switch -- OFF.
2. Taxi and Landing Light Switches -- ON.
3. Engine RPM -- REDUCE to idle.
4. Master Switch -- ON (with taxi and landing lights turned on).
5. Engine RPM -- INCREASE to approximately 1500 RPM.
6. Ammeter and Low-Voltage Warning Light -- CHECK.

**NOTE**

If the ammeter does not show a charge or the low-voltage warning light does not go out, the battery should be removed from the airplane and properly serviced prior to flight.

## **SECTION 5 PERFORMANCE**

There is no change to the airplane performance when the ground service plug receptacle is installed.

## SUPPLEMENT

# OXYGEN SYSTEM

### SECTION 1 GENERAL

A four-place oxygen system provides the supplementary oxygen necessary for continuous flight at high altitude. In this system, an oxygen cylinder, located behind the battery in the aft fuselage, supplies the oxygen. Cylinder pressure is reduced to an operating pressure of 70 psi by a pressure regulator attached to the cylinder. A shutoff valve is included as part of the regulator assembly. An oxygen cylinder filler valve is located behind a removable cover on the left side of the fuselage, aft of the baggage compartment door. Cylinder pressure is indicated by a pressure gage located in the overhead oxygen console.

Four oxygen outlets are provided; two in the overhead oxygen console and two in the cabin ceiling just above the side windows, one at each of the seating positions. One permanent, microphone-equipped mask is provided for the pilot, and three disposable type masks are provided for the passengers. All masks are the partial-rebreathing type equipped with vinyl plastic hoses and flow indicators.

#### NOTE

The hose provided for the pilot is of a higher flow rate than those for the passengers; it is color-coded with an orange band adjacent to the plug-in fitting. The passenger hoses are color-coded with a green band. If the airplane owner prefers, he may provide higher flow hoses for all passengers. In any case, it is recommended that the pilot use the larger capacity hose. The pilot's mask is equipped with a microphone to facilitate use of the radio while using oxygen. An adapter cord is furnished with the microphone-equipped mask to mate the mask microphone lead to the auxiliary microphone jack located on the left side of the instrument panel. To connect the oxygen mask microphone, connect the mask lead to the adapter cord and plug the cord into the auxiliary microphone jack. (If an optional microphone-headset combination has been in

use, the microphone lead from this equipment is already plugged into the auxiliary microphone jack. It will be necessary to disconnect this lead from the auxiliary microphone jack so that the adapter cord from the oxygen mask microphone can be plugged into the jack). A switch is incorporated on the left hand control wheel to operate the microphone.

A remote shutoff valve control, located adjacent to the pilot's oxygen outlet, is used to shut off the supply of oxygen to the system when not in use. The control is mechanically connected to the shutoff valve at the cylinder. With the exception of the shutoff function, the system is completely automatic and requires no manual regulation for change of altitude.

The oxygen cylinder, when fully charged, contains approximately 48 cubic feet of oxygen, under a pressure of 1800 psi at 70°F (21°C). Filling pressures will vary, however, due to the ambient temperature in the filling area, and because of the temperature rise resulting from compression of the oxygen. Because of this, merely filling to 1800 psi will not result in a properly filled cylinder. Fill to the pressures indicated in figure 1 for ambient temperature.

**WARNING**

Oil, grease or other lubricants in contact with oxygen create a serious fire hazard, and such contact must be avoided when handling oxygen equipment.

AMBIENT TEMPERATURE °F	FILLING PRESSURE PSIG	AMBIENT TEMPERATURE °F	FILLING PRESSURE PSIG
0	1600	50	1825
10	1650	60	1875
20	1675	70	1925
30	1725	80	1950
40	1775	90	2000

Figure 1. Oxygen Filling Pressures

## SECTION 2 LIMITATIONS

There is no change to the airplane limitations when oxygen equipment is installed.

## SECTION 3 EMERGENCY PROCEDURES

There is no change to the airplane emergency procedures when oxygen equipment is installed.

## SECTION 4 NORMAL PROCEDURES

For FAA requirements concerning supplemental oxygen, refer to FAR 91.32. Supplemental oxygen should be used by all occupants when cruising above 12,500 feet. As described in the Cessna booklet "Man At Altitude," it is often advisable to use oxygen at altitudes lower than 12,500 feet under conditions of night flying, fatigue, or periods of physiological or emotional disturbances. Also, the habitual and excessive use of tobacco or alcohol will usually necessitate the use of oxygen at less than 10,000 feet.

Prior to flight, check to be sure that there is an adequate oxygen supply for the trip, by noting the oxygen pressure gage reading, and referring to the Oxygen Duration Chart (figure 2). Also, check that the face masks and hoses are accessible and in good condition.

The Oxygen Duration Chart (figure 2) should be used in determining the usable duration (in hours) of the oxygen supply in your airplane. The following procedure outlines the method of finding the duration from the chart.

1. Note the available oxygen pressure shown on the pressure gage.
2. Locate this pressure on the scale on the left side of the chart, then go across the chart horizontally to the right until you intersect the line representing the number of persons making the flight. After intersecting the line, drop down vertically to the bottom of the chart and read the duration in hours given on the scale.
3. As an example of the above procedure, 1400 psi of pressure will

safely sustain the pilot only for nearly 6 hours and 15 minutes. The same pressure will sustain the pilot and three passengers for approximately 2 hours and 30 minutes.

### OXYGEN DURATION CHART (48 CUBIC FEET CAPACITY)

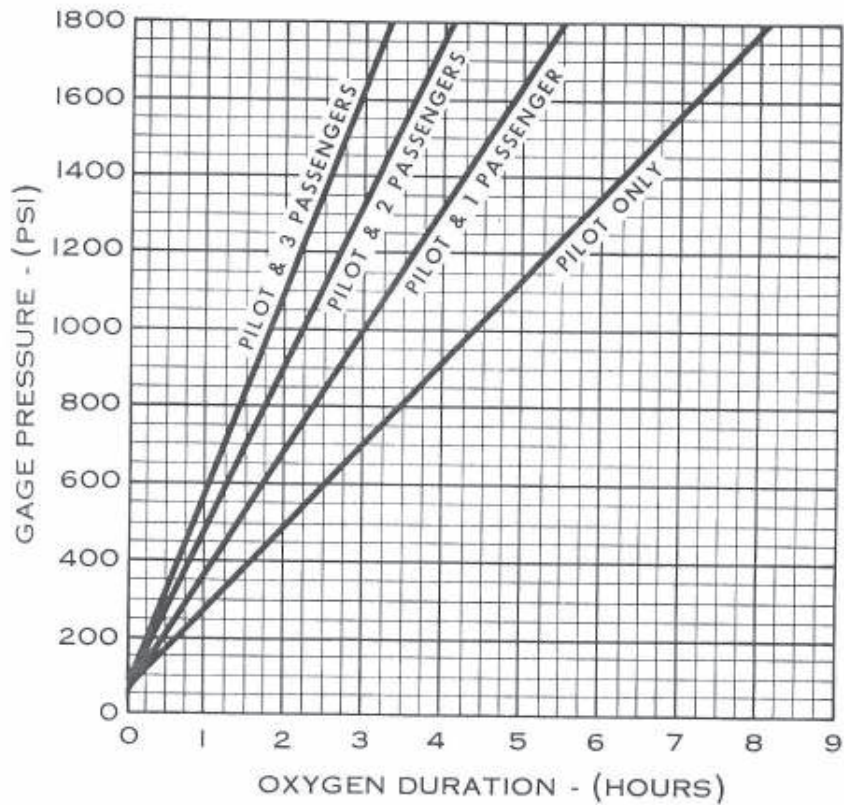

NOTE: This chart is based on a pilot with an orange color-coded oxygen line fitting and passengers with green color-coded line fittings.

Figure 2. Oxygen Duration Chart

**NOTE**

The Oxygen Duration Chart is based on a standard configuration oxygen system having one orange color-coded hose assembly for the pilot and green color-coded hoses for the passengers. If orange color-coded hoses are provided for pilot and passengers, it will be necessary to compute new oxygen duration figures due to the greater consumption of oxygen with these hoses. This is accomplished by computing the total duration available to the pilot only (from PILOT ONLY line on chart), then dividing this duration by the number of persons (pilot and passengers) using oxygen.

When ready to use the oxygen system, proceed as follows:

1. Mask and Hose -- SELECT. Adjust mask to face and adjust metallic nose strap for snug mask fit.

**WARNING**

Permit no smoking when using oxygen. Oil, grease, soap, lipstick, lip balm, and other fatty materials constitute a serious fire hazard when in contact with oxygen. Be sure hands and clothing are oil-free before handling oxygen equipment.

2. Delivery Hose -- PLUG INTO OUTLET nearest to the seat you are occupying.

**NOTE**

When the oxygen system is turned on, oxygen will flow continuously at the proper rate of flow for any altitude without any manual adjustments.

3. Oxygen Supply Control Knob -- ON.
4. Face Mask Hose Flow Indicator -- CHECK. Oxygen is flowing if the indicator is being forced toward the mask.
5. Delivery Hose -- UNPLUG from outlet when discontinuing use of oxygen. This automatically stops the flow of oxygen.
6. Oxygen Supply Control Knob -- OFF when oxygen is no longer required.

**SECTION 5  
PERFORMANCE**

There is no change to the airplane performance when oxygen equipment is installed.



# SUPPLEMENT

## STANDBY VACUUM PUMP

### SECTION 1 GENERAL

The electrical standby vacuum pump provides standby suction necessary to operate the airplane vacuum system, should the normal engine-driven vacuum pump fail in flight. The standby pump is mounted on the aft side of the firewall behind the instrument panel, and is connected in parallel with the engine-driven vacuum pump at the manifold check valve (see figure 1). Control and circuit protection for the pump is provided by a two-position, toggle-type switch/circuit breaker located on the left switch and control panel.

### SECTION 2 LIMITATIONS

IFR flight should not be initiated with an inoperative engine-driven vacuum pump.

### SECTION 3 EMERGENCY PROCEDURES

PRIMARY VACUUM SYSTEM FAILURE (Low Vacuum Warning Light Illuminates And/Or Low Suction Gage Indication)

1. STBY VAC Switch -- ON.
2. Suction Gage -- CHECK VACUUM RESTORED.

#### CAUTION

If vacuum is not restored, with the standby vacuum pump operating, a failure has occurred elsewhere in the vacuum system and partial panel procedures will be necessary as outlined in Section 3 of the basic handbook.

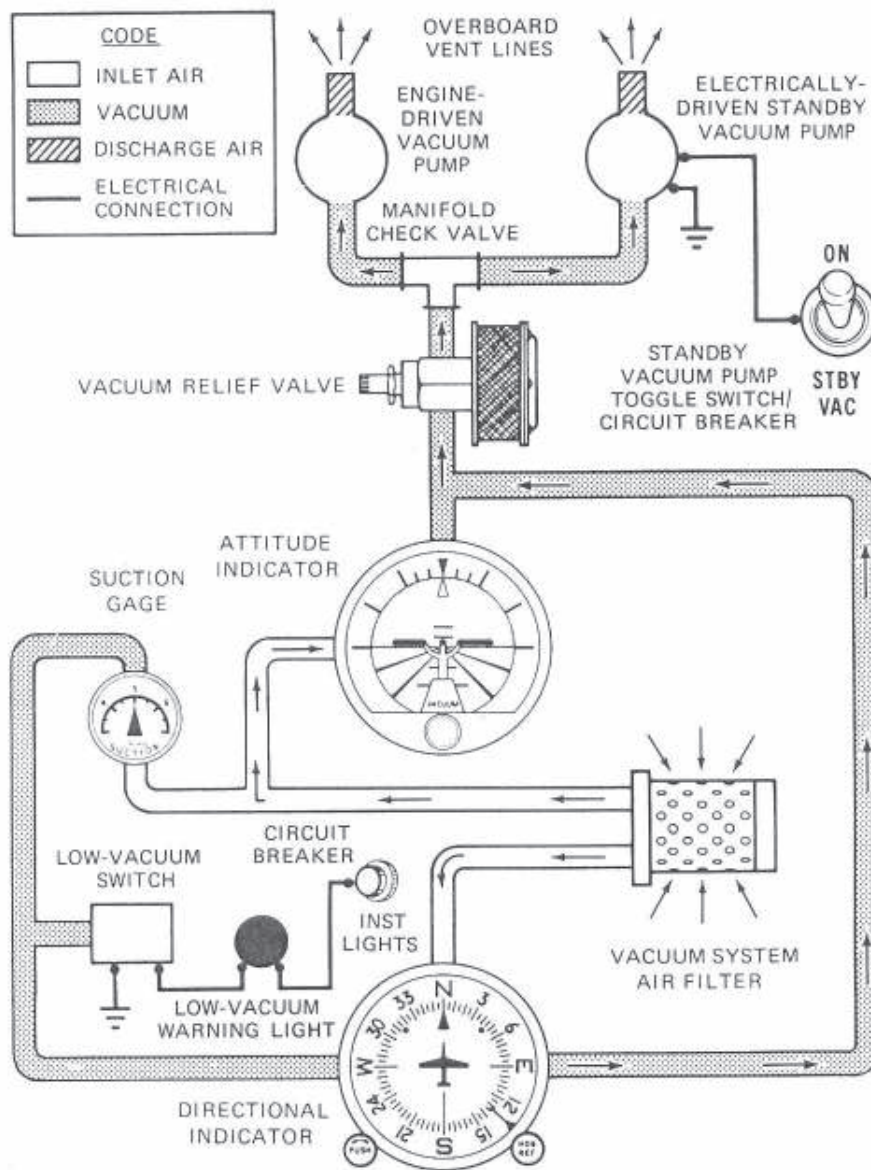

Figure 1. Vacuum System (With Addition of Standby Vacuum Pump)

## SECTION 4 NORMAL PROCEDURES

The following check should be performed during the Cabin Preflight Inspection of the first flight of the day and/or when IFR flight is planned/anticipated:

1. Master Switch -- ON.
2. STBY VAC Switch -- ON (check audibly for operation).
3. Suction Gage -- INDICATION BETWEEN 4.5 AND 5.4 IN. Hg.

### NOTE

Due to lower atmospheric pressures at altitudes of 15,000 feet and above, the suction gage may indicate below 4.5 in. Hg while in flight and still be adequate for normal system operation. Refer to Suction Gage in Section 7 of the basic handbook for additional information.

4. Low-Vacuum Warning Light -- CHECK OFF.
5. STBY VAC Switch -- OFF (down position).
6. Master Switch -- OFF.

### NOTE

A small magnetic compass deviation could exist anytime the standby vacuum pump is operating.

## SECTION 5 PERFORMANCE

There is no change to the airplane performance when the standby vacuum pump is installed.

## SUPPLEMENT

# STROBE LIGHT SYSTEM

### SECTION 1 GENERAL

The high intensity strobe light system enhances anti-collision protection for the airplane. The system consists of two wing tip-mounted strobe lights (with integral power supplies), a rocker switch, labeled STROBE LIGHTS, and a 5-amp "push-to-reset" type circuit breaker, labeled STROBE LIGHT. The rocker switch and circuit breaker are located on the left side of the switch and control panel.

### SECTION 2 LIMITATIONS

Strobe lights must be turned off when taxiing in the vicinity of other airplanes, or during night flight through clouds, fog or haze.

### SECTION 3 EMERGENCY PROCEDURES

There is no change to the airplane emergency procedures when strobe lights are installed.

### SECTION 4 NORMAL PROCEDURES

To operate the strobe light system, proceed as follows:

1. Master Switch -- ON.
2. Strobe Light Switch -- ON.

## **SECTION 5**

### **PERFORMANCE**

The installation of strobe lights will result in a minor reduction in cruise performance.

## SUPPLEMENT

# WINTERIZATION KIT

### SECTION 1 GENERAL

The winterization kit consists of two cover plates (with placards) which attach to the air intakes in the cowling nose cap, a restrictive cover plate for the induction air inlet, a placard to be installed on the instrument panel, and insulation for the crankcase breather line. This equipment should be installed for operations in temperatures consistently below 20° F (-7°C). Once installed, the crankcase breather insulation is approved for permanent use in both hot and cold weather.

### SECTION 2 LIMITATIONS

The following information must be presented in the form of placards when the airplane is equipped with a winterization kit.

1. On each nose cap cover plate and induction air inlet cover plate:

THIS PLATE NOT TO BE USED WHEN  
TEMPERATURE EXCEEDS +20° F.

2. On right side of instrument panel:

WINTERIZATION KIT MUST BE REMOVED  
WHEN OUTSIDE AIR TEMPERATURE IS  
ABOVE 20°F.

### **SECTION 3**

## **EMERGENCY PROCEDURES**

There is no change to the airplane emergency procedures when the winterization kit is installed.

### **SECTION 4**

## **NORMAL PROCEDURES**

There is no change to the airplane normal procedures when the winterization kit is installed.

### **SECTION 5**

## **PERFORMANCE**

There is no change to the airplane performance when the winterization kit is installed.